



BOSCH

DIVAR 2000 / DIVAR 3000 / DIVAR 5000

Network/Hybrid Video Recorder



en

Operation Manual

Table of contents

1	Safety	7
1.1	Important safety instructions	7
1.2	FCC and UL	9
2	Short information	10
3	System overview	11
4	Planning information	12
4.1	Unpacking	12
4.2	Package contents	12
5	Installation	13
5.1	Unpacking	13
5.1.1	Package contents	13
5.2	Make connections	14
5.2.1	Back panel connectors DIVAR network 2000/3000 (no PoE)	15
5.2.2	Back panel connectors DIVAR network 2000 (8 PoE)	16
5.2.3	Back panel connectors DIVAR network 2000/3000 (16 PoE)	17
5.2.4	Back panel connectors DIVAR network 5000 (no PoE)	18
5.2.5	Back panel connectors DIVAR network 5000 (16 PoE)	19
5.2.6	Back panel connectors DIVAR hybrid 3000	20
5.2.7	Back panel connectors DIVAR hybrid 5000	21
5.2.8	Browser setup	21
5.3	Powering up	22
5.4	Startup wizard	22
5.5	Login	23
5.6	Logout/Shutdown	23
6	First time operation	24
6.1	Live viewing mode	24
6.2	Quick menu	25
6.3	Main menu	25
7	Hardware setup	27
7.1	Keyboard connection (only DIVAR 5000 models)	27
7.1.1	Connect using RJ11 adapter	28
7.1.2	Connect wires directly	29
7.2	RS485 port connection (only hybrid models)	29
7.3	RS232 port connections	30
7.4	Alarm I/O connections	31
8	Settings	32
8.1	System	32
8.1.1	General	32
8.1.2	Playback	33
8.1.3	Display	33
8.1.4	Serial port	35
8.1.5	Text/Pos (only on hybrid recorders)	36
8.1.6	Account	36
8.1.7	Service	37
8.2	Network	39
8.2.1	Connection	39
8.2.2	DDNS	41
8.2.3	Mobile	42

8.2.4	Bandwidth	42
8.2.5	UPnP	43
8.2.6	PPPoE	43
8.2.7	SNMP	43
8.2.8	Email	44
8.2.9	Storage	44
8.2.10	IP filter	45
8.2.11	Certificates	45
8.3	Camera	46
8.3.1	Detection	46
8.3.2	Configuration	46
8.3.3	Recording	47
8.3.4	Installer	50
8.3.5	Maintenance	51
8.3.6	Channel type	52
8.4	Alarm	53
8.4.1	Motion detect	53
8.4.2	Video loss	54
8.4.3	Input alarm	54
8.4.4	System alarm	54
8.4.5	Alarm Out	55
8.5	Schedule	56
8.5.1	Weekdays and Holidays	56
8.6	Storage	57
8.6.1	HDD manage	57
8.6.2	Recording	57
9	Operation	59
9.1	User controls and menus	59
9.1.1	Mouse Controls	59
9.1.2	Front panel controls	60
9.1.3	Remote control	62
9.1.4	Quick menu	65
9.1.5	Main menu	65
9.2	Live screen	65
9.2.1	Live mode	66
9.2.2	Pan/Tilt/Zoom	67
9.2.3	Sequence	67
9.2.4	Monitor A	68
9.2.5	Monitor B (only for DIVAR 5000 models)	68
9.3	Playback	69
9.3.1	Export	75
9.3.2	Export snapshot	75
9.4	Info	75
9.4.1	System Alarm	75
9.4.2	System Health	75
9.4.3	System Version	76
9.4.4	Network Online users	76
9.4.5	PoE usage	76
9.4.6	Network Load	76

9.4.7	Network Test	76
9.4.8	HDD General	77
9.4.9	HDD Health	77
9.4.10	Log	78
9.5	Export	78
9.6	Event search	79
10	Archive Player operation	80
10.1	Getting started	80
10.1.1	System requirements	80
10.1.2	Installation	80
10.1.3	Starting the Player	80
10.2	Authentication (checking watermark)	83
10.3	Export file	83
10.4	Configuration	84
11	Web Client Software	85
11.1	Getting started	85
11.2	How to log on	86
11.3	Web client live window	86
11.3.1	Live	86
11.3.2	Playback mode	87
11.3.3	Event search	87
11.3.4	Export	87
11.3.5	Setting	88
11.3.6	Info	88
11.3.7	Logout	88
12	DIVAR Mobile Viewer	89
12.1	Getting started	89
12.2	Live Preview	89
12.3	Playback	90
12.4	Device Manager	90
12.5	Local Files	91
12.6	Favorites	91
12.7	Alarms and Push notifications	91
12.8	More	91
13	Troubleshooting	93
14	Maintenance	97
14.1	Insert DIVAR 5000 in rack	97
14.2	Replace internal battery	97
14.3	Install HDD	97
14.4	Install DVD	97
15	Decommissioning	98
15.1	Transfer	98
15.2	Disposal	98
16	Technical data	99
17	Appendices	101
17.1	Software licenses	101
17.1.1	Bosch software	101
17.1.2	Other licenses – copyright notices	101
17.1.3	Warranties and disclaimer of warranties	102

17.2	DVD Compatibility	102
17.3	HDD Compatibility	103

1**Safety****Warning!**

Indicates a hazardous situation which, if not avoided, could result in death or serious injury.

**Caution!**

Indicates a hazardous situation which, if not avoided, could result in minor or moderate injury.

**Notice!**

Indicates a situation which, if not avoided, could result in damage to the equipment or environment, or data loss.

1.1**Important safety instructions**

Video loss - Video loss is inherent to digital video recording; therefore, Bosch Security Systems cannot be held liable for any damage that results from missing video information. To minimize the risk of losing information, we recommend multiple, redundant recording systems, and a procedure to back up all analog and digital information.



Accessories - Do not place this unit on an unstable stand, tripod, bracket, or mount. The unit may fall, causing serious injury and/or serious damage to the unit. Use only with the cart, stand, tripod, bracket, or table specified by the manufacturer. When a cart is used, use caution and care when moving the cart/apparatus combination to avoid injury from tip-over. Quick stops, excessive force, or uneven surfaces may cause the cart/unit combination to overturn. Mount the unit per the manufacturer's instructions.

Read, follow, and retain for future reference all of the following safety instructions. Heed all warnings on the unit and in the operating instructions before operating the unit.

1. **Cleaning** - Unplug the unit from the outlet before cleaning. Follow any instructions provided with the unit. Generally, using a dry cloth for cleaning is sufficient but a moist, fluff-free cloth or leather shammy may also be used. Do not use liquid cleaners or aerosol cleaners.
2. **Heat Sources** - Do not install the unit near any heat sources such as radiators, heaters, stoves, or other equipment (including amplifiers) that produce heat.
3. **Ventilation** - Any openings in the unit enclosure are provided for ventilation to prevent overheating and ensure reliable operation. Do not block or cover these openings. Do not place the unit in an enclosure unless proper ventilation is provided, or the manufacturer's instructions have been adhered to.
4. **Water** - Do not use this unit near water, for example near a bathtub, washbowl, sink, laundry basket, in a damp or wet basement, near a swimming pool, in an outdoor installation, or in any area classified as a wet location. To reduce the risk of fire or electrical shock, do not expose this unit to rain or moisture.

5. **Object and liquid entry** - Never push objects of any kind into this unit through openings as they may touch dangerous voltage points or short-out parts that could result in a fire or electrical shock. Never spill liquid of any kind on the unit. Do not place objects filled with liquids, such as vases or cups, on the unit.
6. **Lightning** - For added protection during a lightning storm, or when leaving this unit unattended and unused for long periods, unplug the unit from the wall outlet and disconnect the cable system. This will prevent damage to the unit from lightning and power line surges.
7. **Controls adjustment** - Adjust only those controls specified in the operating instructions. Improper adjustment of other controls may cause damage to the unit. Use of controls or adjustments, or performance of procedures other than those specified, may result in hazardous radiation exposure.
8. **Overloading** - Do not overload outlets and extension cords. This can cause fire or electrical shock.
9. **Power supply cord and plug protection** - Power supply cords should be routed so that they are not likely to be walked on or pinched by items placed upon or against them, paying particular attention to cords and plugs, convenience receptacles, and the point where they exit from the appliance.
10. **Power disconnect** - Units have power supplied to the unit whenever the power cord is inserted into the power source. The power cord plug is the main power disconnect device for switching off the voltage for the unit.
11. **Power sources** - Operate the unit only from the type of power source indicated on the label. Before proceeding, be sure to disconnect the power from the cable to be installed into the unit.
12. **Servicing** - Do not attempt to service this unit yourself. Opening or removing covers may expose you to dangerous voltage or other hazards. Refer all servicing to qualified service personnel.
13. **Damage requiring service** - Unplug the power unit from the main AC power source and refer servicing to qualified service personnel when any damage to the equipment has occurred, such as:
 - the power supply cord or plug is damaged;
 - exposure to moisture, water, and/or inclement weather (rain, snow, etc.);
 - liquid has been spilled in or on the equipment;
 - an object has fallen into the unit;
 - unit has been dropped or the unit cabinet is damaged;
 - unit exhibits a distinct change in performance;
 - unit does not operate normally when the user correctly follows the operating instructions.
14. **Replacement parts** - Be sure the service technician uses replacement parts specified by the manufacturer, or that have the same characteristics as the original parts. Unauthorized substitutions could void the warranty and cause fire, electrical shock, or other hazards.
15. **Safety check** - Safety checks should be performed upon completion of service or repairs to the unit to ensure proper operating condition.
16. **Installation** - Install in accordance with the manufacturer's instructions and in accordance with applicable local codes.

17. **Attachments, changes or modifications** - Only use attachments/accessories specified by the manufacturer. Any change or modification of the equipment, not expressly approved by Bosch, could void the warranty or, in the case of an authorization agreement, authority to operate the equipment.

1.2

FCC and UL

FCC & ICES Information

This equipment has been tested and found to comply with the limits for a **Class B** digital device, pursuant to *part 15* of the *FCC Rules*. These limits are designed to provide reasonable protection against harmful interference in a **residential installation**. This equipment generates, uses, and can radiate radio frequency energy and, if not installed and used in accordance with the instructions, may cause harmful interference to radio communications. However, there is no guarantee that interference will not occur in a particular installation. If this equipment does cause harmful interference to radio or television reception, which can be determined by turning the equipment off and on, the user is encouraged to try to correct the interference by one or more of the following measures:

- reorient or relocate the receiving antenna;
- increase the separation between the equipment and receiver;
- connect the equipment into an outlet on a circuit different from that to which the receiver is connected;
- consult the dealer or an experienced radio/TV technician for help.

Intentional or unintentional modifications, not expressly approved by the party responsible for compliance, shall not be made. Any such modifications could void the user's authority to operate the equipment. If necessary, the user should consult the dealer or an experienced radio/television technician for corrective action.

The user may find the following booklet, prepared by the Federal Communications Commission, helpful: *How to Identify and Resolve Radio-TV Interference Problems*. This booklet is available from the U.S. Government Printing Office, Washington, DC 20402, Stock No. 004-000-00345-4.

UL Disclaimer

Underwriter Laboratories Inc. ("UL") has not tested the performance or reliability of the security or signaling aspects of this product. UL has only tested fire, shock and/or casualty hazards as outlined in Standard(s) for Safety for Information Technology Equipment, UL 60950-1. UL Certification does not cover the performance or reliability of the security or signaling aspects of this product.

UL MAKES NO REPRESENTATIONS, WARRANTIES, OR CERTIFICATIONS WHATSOEVER REGARDING THE PERFORMANCE OR RELIABILITY OF ANY SECURITY OR SIGNALING-RELATED FUNCTIONS OF THIS PRODUCT.

2 Short information

This manual has been compiled with great care and the information it contains has been thoroughly verified. The text was correct at the time of printing, however, the content can change without notice. Bosch Security Systems accepts no liability for damage resulting directly or indirectly from faults, incompleteness or discrepancies between this manual and the product described.

Trademarks

All hardware and software product names used in this document are likely to be registered trademarks and must be treated accordingly.

More information

For more information please contact the nearest Bosch Security Systems location or visit www.boschsecurity.com

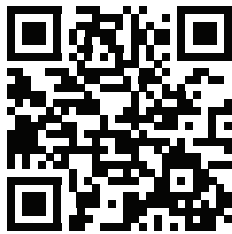

http://www.boschsecurity.com/catalog_overview.htm

3 System overview

The recorder can be connected to cameras that use the latest H.264/H.265 high-resolution video technology and state-of-the-art compression techniques. These advanced technologies, coupled with efficient network data transmission, deliver the high security and reliability required for modern surveillance systems.

Simultaneous remote or local monitoring, recording, archiving and playback are guided by simple menu selections and operator commands. The recorders can be installed with optional HDDs for video storage; plus a DVD burner for video export.

**Notice!**

Bosch strongly recommends upgrading to the latest firmware for the best possible functionality, compatibility, performance and security.

Check <http://downloadstore.boschsecurity.com/> regularly to see if there is a new firmware version available.

**Notice!**

Bosch strongly recommends to use https (instead of http) for secure communication.

4 Planning information

4.1 Unpacking

This equipment should be unpacked and handled with care. If an item appears to have been damaged in shipment, notify the shipper immediately.

Verify that all parts are included. If any items are missing, notify your Bosch Security Systems Sales or Customer Service Representative.

The original packaging is the safest container in which to transport the unit and can be used if returning the unit for service.

4.2 Package contents

Qty	Component
1	Recorder
1	Optical disc containing software licenses and user documentation
2	Power supply cables (120VAC US type; 230VAC Euro type)
1	External power supply adapter (only for DIVAR 2000/3000 network (non-PoE) models and DIVAR 3000 hybrid models)
	Terminal connector blocks
1	19" mounting set including brackets and screws (only on DIVAR 5000 models)
1	Hard disk mounting kit (including SATA cables, brackets and screws)
1	Optical USB mouse
1	IR remote Control with 2 AA (1.5 V) batteries
1	Ground screw
1	Split cable for loop through to 25-pin D-connector (only for DIVAR 5000 hybrid models)
1	RJ11 adapter cable to connect Bosch Intuikey keyboard (only on DIVAR 5000 models)
	Installation guides for Recorder, HDD, plus safety instructions

5 Installation



Notice!

Use proper surge suppression on cables that are routed outdoors, or close to large inductive loads or electrical mains supply cables.



Caution!

Installation should only be performed by qualified service personnel in accordance with the National Electrical Code (NEC 800 CEC Section 60) or applicable local codes.

To get the unit operational, perform the following quick install steps:

1. Carefully unpack the recorder from its shipping packaging – see Unpacking.
2. Make all required hardware connections – see ‘Make Connections’.
3. Power up the system – see Powering Up.
4. Log in – see Login.
5. Correctly configure your system software with the Startup wizard (this appears the first time the unit is started) – see Startup Wizard.

After completing this initial setup, the system is ready to run and will show a live view of the camera image(s). If required, you can alter the settings later using the menus and/or factory defaults, or you can run the Startup wizard again.

5.1 Unpacking

This equipment should be unpacked and handled with care. If an item appears to have been damaged in shipment, notify the shipper immediately. Verify that all parts are included. If any items are missing, notify your Bosch Security Systems Sales or Customer Service Representative. The original packaging is the safest container in which to transport the unit and can be used if returning the unit for service.

5.1.1 Package contents

Qty	Component
1	Recorder
1	Optical disc containing software licenses and user documentation
2	Power supply cables (120VAC US type; 230VAC Euro type)
1	External power supply adapter (only for DIVAR 2000/3000 network (non-PoE) models and DIVAR 3000 hybrid models)
	Terminal connector blocks
1	19” mounting set including brackets and screws (only on DIVAR 5000 models)
1	Hard disk mounting kit (including SATA cables, brackets and screws)
1	Optical USB mouse
1	IR remote Control with 2 AA (1.5 V) batteries
1	Ground screw



Qty	Component
1	Split cable for loop through to 25-pin D-connector (only for DIVAR 5000 hybrid models)
1	RJ11 adapter cable to connect Bosch Intuikey keyboard (only on DIVAR 5000 models)
	Installation guides for Recorder, HDD, plus safety instructions

5.2 Make connections





Notice!

Use only PoE approved devices.





1. Connect the cameras to the **VIDEO IN** or  connectors.
 - If using PoE connector, power is supplied to the camera via the Ethernet cable compliant with the Power-over-Ethernet standard.
 - Use an external switch to connect more cameras to a single RJ45  port.
2. Connect monitor A to the **HDMI MON.A** output, or the **VGA MON.A** output.
3. Connect the USB mouse to a **USB** port (back or front panel).

Optional connections (depending on model)

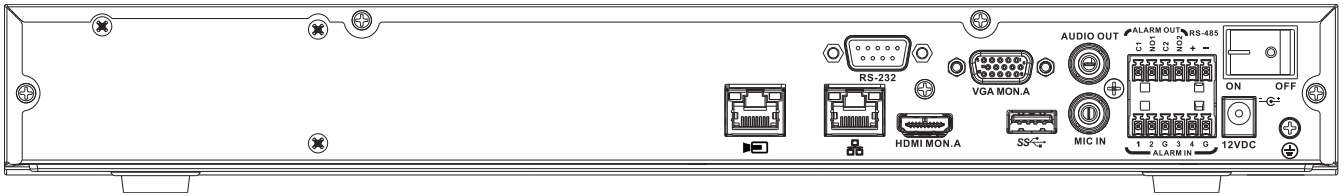
1. On DIVAR 5000 models, connect a second dual monitor to the **HDMI MON.B** (hybrid models) or **HDMI MON.A2** (network models) connector.
2. Connect up to 4 audio signals to the **AUDIO IN** RCA (CINCH) inputs.
3. Connect 1 microphone to the **MIC IN** RCA (CINCH) input.
4. Connect 1 RCA (CINCH) output from **AUDIO OUT** to the monitor or an audio amplifier.
5. Connect up to 16 alarm inputs to the **ALARM IN** connector (via the supplied terminal blocks) – see description in **Hardware setup**.
6. Connect up to 6 alarm outputs to the **ALARM OUT** connector (via the supplied terminal blocks) – see description in **Hardware setup**.
7. Connect a pan/tilt/zoom control unit to the **RS-485** (only for hybrid models) – see description in **Hardware setup**.
8. Connect to your network via the RJ45 **ETHERNET** connector  (use Shielded Twisted Pair Category 5e cable).
9. Connect extra video out cables to the **VIDEO OUT** ports if loop through is required to other devices (only for DIVAR 5000 hybrid).
10. Connect a Bosch Intuikey keyboard cable to the **KEYBOARD** connector using the supplied adaptor (only for DIVAR 5000) – see description in **Hardware setup**.
11. Connect an eSATA storage device to the **eSATA** connector (only for DIVAR 5000).
12. Connect the DIVAR to an approved ground point. Use the ground screw (supplied in the accessory bag) to attach a ground cable to the DIVARback panel ground point .





5.2.1 Back panel connectors DIVAR network 2000/3000 (no PoE)

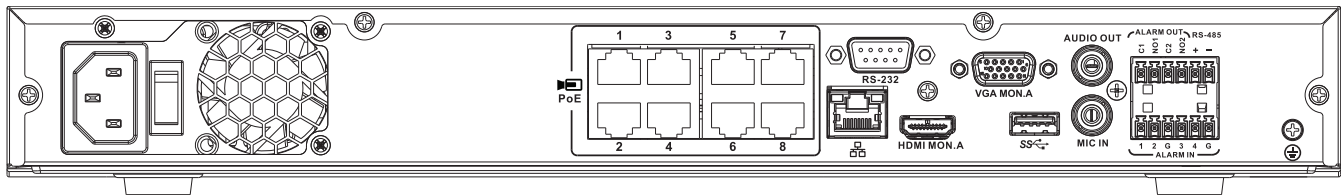

	RJ45 video input for max. 32 IP cameras (max. 16 IP cameras for DIVAR 2000) connected via external switch (optional with DHCP configuration)
	RJ45 Ethernet connection (10/100/1000Base-T according to IEEE802.3)
VGA MON.A	1 D-SUB (Monitor output)
HDMI MON.A	1 HDMI (Monitor output)
ALARM IN	4 screw terminal inputs, cable diameter AWG26-16 (0.4–1.29 mm)
ALARM OUT	2 screw terminal outputs, cable diameter AWG26-16 (0.4–1.29 mm)
AUDIO OUT	1 RCA (Audio output)
MIC IN	1 RCA (Audio input)
RS-485	Screw terminal output
RS-232	DB9 male, 9-pin D-type
	One USB (3.0) connector for mouse or USB memory device; one USB (2.0) also on front panel
Power input with On/Off switch	12 VDC (5 A) AC input adapter: 100~240 VAC, 50-60 Hz, 1.5 A
	Ground connection





5.2.2 Back panel connectors DIVAR network 2000 (8 PoE)

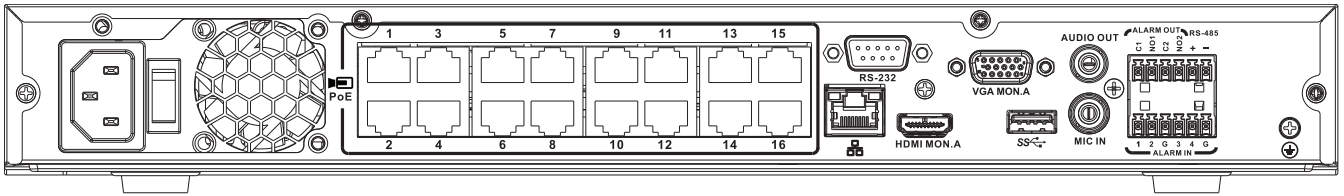

 PoE	Max. 8 RJ45 PoE ports (115 W; 25.5 W max. per port) connected with DHCP configuration (maximum 16 IP channels possible)
	RJ45 Ethernet connection (10/100/1000Base-T according to IEEE802.3)
VGA MON.A	1 D-SUB (Monitor output)
HDMI MON.A	1 HDMI (Monitor output)
ALARM IN	4 screw terminal inputs, cable diameter AWG26-16 (0.4–1.29 mm)
ALARM OUT	2 screw terminal outputs, cable diameter AWG26-16 (0.4–1.29 mm)
AUDIO OUT	1 RCA (Audio output)
MIC IN	1 RCA (Audio input)
RS-485	Screw terminal output
RS-232	DB9 male, 9-pin D-type (for service)
	One USB (3.0) connector for mouse or USB memory device; One USB (2.0) also on front panel
Power input with On/Off switch	100~240 VAC, 50-60 Hz, 3.5 A, 190 W
	Ground connection





5.2.3 Back panel connectors DIVAR network 2000/3000 (16 PoE)

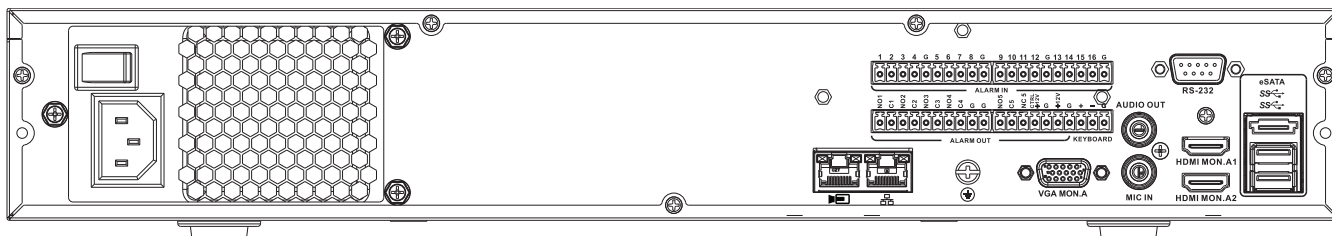

 PoE	Max. 16 PoE ports (130 W; 25.5 W max. per port) connected with DHCP configuration (max. 16 IP cameras for DIVAR 2000; max 32 IP cameras for DIVAR 3000)
	RJ45 Ethernet connection (10/100/1000Base-T according to IEEE802.3)
VGA MON.A	1 D-SUB (Monitor output)
HDMI MON.A	1 HDMI (Monitor output)
ALARM IN	4 screw terminal inputs, cable diameter AWG26-16 (0.4–1.29 mm)
ALARM OUT	2 screw terminal outputs, cable diameter AWG26-16 (0.4–1.29 mm)
AUDIO OUT	1 RCA (Audio output)
MIC IN	1 RCA (Audio input)
RS-485	Screw terminal output
RS-232	DB9 male, 9-pin D-type
	One USB (3.0) connector for mouse or USB memory device; one USB (2.0) also on front panel
Power input with On/Off switch	100~240 VAC, 50-60 Hz, 3.5 A, 190 W
	Ground connection





5.2.4 Back panel connectors DIVAR network 5000 (no PoE)

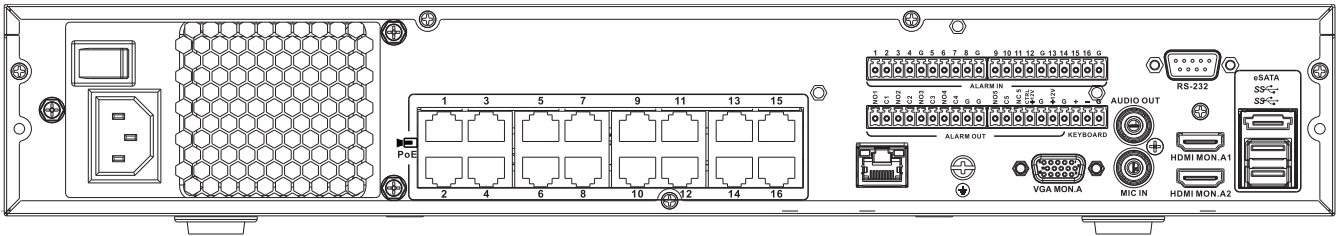

	RJ45 video input for max. 32 IP cameras connected via external switch (optional with DHCP configuration)
	RJ45 Ethernet connection (10/100/1000Base-T according to IEEE802.3)
VGA MON.A	1 D-SUB (Monitor output)
HDMI MON.A1	1 HDMI (Monitor output in maximum 4k resolution)
HDMI MON.A2	1 HDMI (output for spot monitor that supports live multiscreen)
ALARM IN	16 screw terminal inputs, cable diameter AWG26-16 (0.4–1.29 mm)
ALARM OUT	6 screw terminal outputs, cable diameter AWG26-16 (0.4–1.29 mm)
KEYBOARD	Screw terminals, cable diameter AWG26-16 (0.4–1.29 mm)
AUDIO OUT	1 RCA (Audio output)
MIC IN	1 RCA (Audio input)
RS-232	DB9 male, 9-pin D-type (for service)
	Two USB (3.0) connectors for mouse or USB memory device; one USB (2.0) also on front panel
eSATA	For backup/memory device
Power input with On/Off switch	100~240 VAC, 50-60 Hz, 1.9 A, 75 W
	Ground connection





5.2.5 Back panel connectors DIVAR network 5000 (16 PoE)

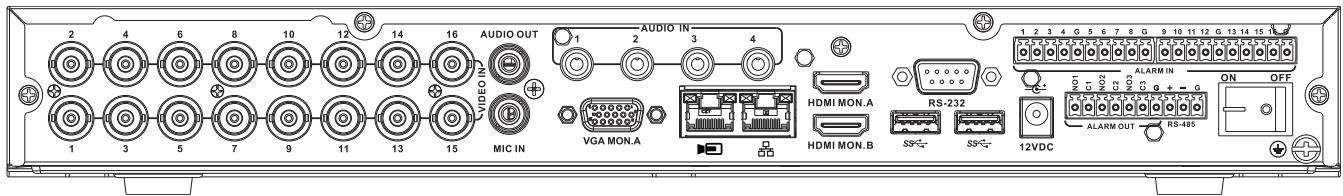

 PoE	16 RJ45 ports (200 W; max. 25.5 W per port) for connecting max. 16 PoE cameras connected with DHCP configuration (max. 32 IP cameras)
	RJ45 Ethernet connection (10/100/1000Base-T according to IEEE802.3)
VGA MON.A	1 D-SUB (Monitor output)
HDMI MON.A1	1 HDMI (Monitor output in maximum 4k resolution)
HDMI MON.A2	1 HDMI (output for spot monitor that supports live multiscreen)
ALARM IN	16 screw terminal inputs, cable diameter AWG26-16 (0.4–1.29 mm)
ALARM OUT	6 screw terminal outputs, cable diameter AWG26-16 (0.4–1.29 mm)
KEYBOARD	Screw terminals, cable diameter AWG26-16 (0.4–1.29 mm)
AUDIO OUT	1 RCA (Audio output)
MIC IN	1 RCA (Audio input)
RS-232	DB9 male, 9-pin D-type
	Two USB (3.0) connectors for mouse or USB memory device; one USB (2.0) also on front panel
eSATA	For backup/memory device
Power input with On/Off switch	100~240 VAC, 50-60 Hz, 5 A, 350 W
	Ground connection





5.2.6 Back panel connectors DIVAR hybrid 3000

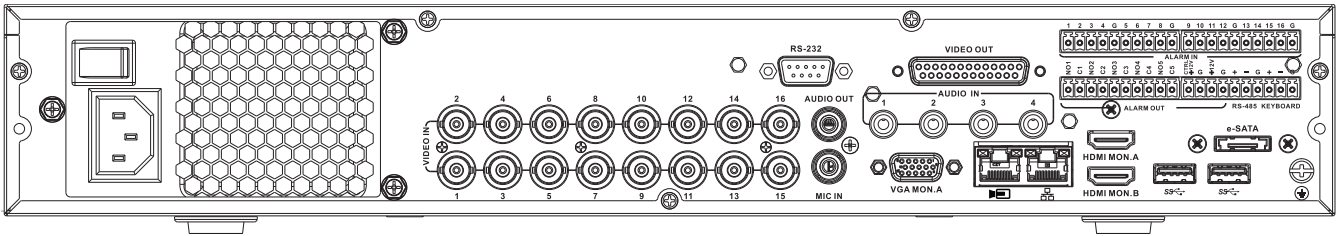

VIDEO IN	16 BNC for connecting max. 16 analog cameras
	Max. 16 IP cameras connected via external switch (if no analog cameras are connected, an extra 16 IP cameras can be connected)
	RJ45 Ethernet connection (10/100/1000Base-T according to IEEE802.3)
VGA MON.A	1 D-SUB (Monitor output)
HDMI MON.A	1 HDMI (Monitor output)
HDMI MON.B	1 HDMI (output for spot monitor)
ALARM IN	16 screw terminal inputs, cable diameter AWG26-16 (0.4–1.29 mm)
ALARM OUT	3 screw terminal outputs, cable diameter AWG26-16 (0.4–1.29 mm)
AUDIO IN	4 RCA (Audio inputs)
AUDIO OUT	1 RCA (Audio output)
MIC IN	1 RCA (Audio input)
RS-485	Screw terminal output (Dome control)
RS-232	DB9 male, 9-pin D-type (Dome control)
	One front (2.0) and two rear (3.0) USB connectors for mouse or USB memory device
Power input with On/Off switch	12 VDC (5 A) AC input adapter: 100~240 VAC, 50-60 Hz, 1.5 A
	Ground connection

5.2.7 Back panel connectors DIVAR hybrid 5000



VIDEO IN	16 BNC for connecting max. 16 analog cameras
	Max. 16 IP cameras connected with external switch (if no analog cameras are connected, an extra 16 IP cameras can be connected)
	RJ45 Ethernet connection (10/100/1000Base-T according to IEEE802.3)
VGA MON.A	1 D-SUB (Monitor output)
HDMI MON.A	1 HDMI (Monitor output)
HDMI MON.B	1 HDMI (output for spot monitor that supports live multiscreen)
ALARM IN	16 screw terminal inputs, cable diameter AWG26-16 (0.4–1.29 mm)
ALARM OUT	6 screw terminal outputs, cable diameter AWG26-16 (0.4–1.29 mm)
AUDIO IN	4 RCA (Audio inputs)
AUDIO OUT	1 RCA (Audio output)
MIC IN	1 RCA (Audio input)
RS-485	Screw terminal output (Dome control)
KEYBOARD	Screw terminal output (Keyboard)
VIDEO OUT	D-sub (loop through to other devices)
RS-232	DB9 male, 9-pin D-type (Dome control)
	Two USB (3.0) connectors for mouse or USB memory device; one USB (2.0) also on front panel
eSATA	For backup/memory device
Power input with On/Off switch	100~240 VAC, 50-60 Hz, 1.9 A, 75 W
	Ground connection

5.2.8 Browser setup

Use a computer with an internet browser to receive live images, control the unit, and replay stored sequences. The unit can also be configured over the network using the browser.

5.3 Powering up

For units with an external power adapter

1. Switch on all equipment connected to unit.
2. Connect the DC power cord of the power adaptor to the **12 VDC** connector on the unit.
3. Connect the AC power cord to the power adaptor.
4. Connect the power adaptor to an AC power outlet.
5. Turn on the unit power ON/OFF switch on the rear of the unit.

For units with 230 VAC input

1. Switch on all equipment connected to unit.
2. Connect the power cable to the unit.
3. Connect the power cable to the AC power outlet.
4. Turn on the unit power ON/OFF switch on the rear of the unit.

5.4 Startup wizard

The Startup Wizard opens automatically when you start your system for the first time. The wizard will guide you through five setup screens (use the buttons **<Default>**, **<Cancel>**, **<Previous>**, **<Next>** to enter values and navigate through the screens):

1. **Screen 1**
Select your language.
Click **<Next>**.
2. **Screen 2**
Assign a User name and password.
The password should at least:
 - contain a minimum of 8 characters
 - use both uppercase and lowercase characters
 - include one or more numerical digits
 - include one or more special characters (! ? # \$ % = + * -)
3. Optionally, assign a security question and answer (useful if you forget your password).
Click **<Next>**.
4. **Screen 3**
Enter the system time and date.
If required, assign the daylight saving time (DST) fields.
Click **<Next>**.
5. **Screen 4**
Leave DHCP selected as default to automatically assign the external network details for the recorder (or) de-select DHCP and assign network details manually.
Optionally scan the QR code to download the mobile app.
Click **<Next>**.
6. **Screen 5**
Click **<Device search>** to search for any connected IP cameras (analog cameras connected to hybrid recorders and IP cameras connected to PoE ports will be automatically assigned).
Select the required cameras in the Search list and add by clicking **<Add>** (or double click a camera). Selected cameras appear in the Device list (if required select one or more channels and **Authenticate**, **Modify** or **Delete** any connected cameras in the Device list).
Click **<Finished>**.
7. The startup wizard is finished, confirm the setup by clicking **<OK>**.

**Notice!**

Use **<Cancel>** to automatically install all factory defaults and exit the Startup wizard.

5.5

Login

Log in to your recorder by entering your user name and password, then click **<OK>**.
Use the supplied USB mouse, front panel, remote control or keyboard to input data and commands.

5.6

Logout/Shutdown

Quick logout

Right-click the mouse to access the **Quick menu**; and choose the option **Logout user**.

Shutdown/Logout via Main menu

1. Right-click the mouse to access the **Quick menu**; from here choose the option **Main menu**.
2. Select the **Shutdown** option on the **Main menu**.
3. Use the menu to choose from the following options:
 - Shutdown**
 - Logout (logout user)**
 - Restart (Restart system)**
4. Click **<OK>** to confirm the selection.

Shut down with power button

Another way to shut down the system is to press the power button on the front panel for at least 3 seconds (the system will automatically backup video recordings and settings).
Start up the system again (and access login screen) by briefly pressing the power button.

6 First time operation

6.1 Live viewing mode

Once the Startup Wizard is completed, your monitor will show the live viewing mode with 1 to 32 real-time images on the display (from a maximum 32 connected cameras). The system date and time is displayed in the top right corner of the screen, and the channel ID is shown in the bottom left of each channel display.



From here, use the mouse (or front panel buttons, or remote control) to control your system via on-screen icons and the **Quick menu** (accessible by right-clicking the mouse).

Make any required configuration changes via the **Main menu** (last selection on **Quick menu**).

- To change system date and time, use **Main menu > Setting > System > Date & Time**.
- To modify the channel ID, see display settings (**Main menu > Setting > Camera > Configuration**).
- To change the camera view configuration, access the **Quick menu** and select View 1, 4, 8, 9, 16 or 32.

If multiple channels are displayed, double-click on a particular channel to show this channel in full-screen (double-click on it again to return to multiple-channel view). The currently selected channel is shown with a green border.

Each channel may also display one or more of the following icons:



	Recording – shows a channel is recording
	Motion detection – a movement has been detected in the camera view



Instant playback, Zoom, Snapshot and Remote

Move the mouse to the top of a camera display to show the control bar:



Click an icon for the following functions:

Icon	Name	Function
	Instant playback	<p>Playback the previous 1-60 minutes recorded on the current channel (default is 5 minutes). Click the play bar to any playback start time (use the pause and exit functions as required). During playback:</p> <ul style="list-style-type: none"> – channel id and record status of current channel are hidden (they only reappear once you exit preview playback) – you can not switch the displayed channel or change current window-display mode <p>Set the playback time in Main menu > Setting > Playback.</p> <p>Note: The system may pop up a dialog box if there is no recorded data for the current channel, or you need to accept a disclaimer before playing.</p>
	Snapshot	<p>Make a snapshot of the current channel display. The system will ask to export the snapshot to an email address, a USB memory device, and/or a DVD:</p>

		<p>Note: A disclaimer screen may initially appear when you first select Snapshot (click <Accept> to continue).</p>
	<p>Zoom</p>	<p>Zoom in on a specified zone of current channel (also supported in multiple-channel view).</p> <ol style="list-style-type: none"> 1. Click the Zoom icon - it will change to . 2. Hold down the left mouse button while selecting a screen area. 3. Release the button to zoom in on the selected area. 4. Right-click the mouse to exit the zoomed area. 5. Exit the zoom function by clicking on the icon again – it will change back to .

6.2 Quick menu

When in live viewing mode, right-click the mouse for the **Quick menu**. Options here are:

- View 1, 4, 8, 9, 16, 32** - choose here the number of view windows shown on Monitor A (one-window, four-windows, nine-windows, 16-windows or 32-windows). For each window view, select also which channels (cameras) to display
- View monitor B** (optional) - a popup appears where you can assign the view windows and channels for images to be shown on monitor B
- Assign camera** - assign the 1st or 2nd stream of a camera to the selected view window
- Save View** - save the current layout of view windows in a new view or overwrite an existing view
- Pan/Tilt/Zoom** - only possible if you have a PTZ camera attached and configured
- Search/Play** - search for records, and play/export them
- Event search** - search for events (alarms), and play/export them
- Snapshot** - make a snapshot of the current live camera images:
 - A disclaimer screen may initially appear when you select **Snapshot** (click **<Accept>** to continue).
 - Choose to export the snapshot to an email address, a USB memory device, and/or a DVD.
- Sequence on** - activate a camera tour sequence on Monitor A (to disable the sequence, access Quick Menu again and select 'Sequence off')
- Alarm output** - access the alarm output screen to configure the alarm output relays
- Logout user** - logout the current user (a popup appears to confirm logout)
- Main menu** - for settings and user modes



Notice!

The Pan/Tilt/Zoom setting applies for the currently selected channel. If you are in multiple-window mode, the system automatically switches to the corresponding channel.

6.3 Main menu

Access the Main menu as follows:

- Use the Enter key and the direction buttons on the front panel or the remote control
- Right-click the mouse for the quick menu and select '**Main menu**'

Here you can select the following sub-menus:

- **Playback** to play recordings
- **Event search** to search for events/alarms over a set period (all events can be previewed, played and exported as required)
- **Export** to export your recorded files to a memory device
- **Setting** for system configuration
- **Info** for relevant system status information
- **Shutdown** - shutdown or restart your system, plus logout

7 Hardware setup

This chapter contains detailed information about the hardware installation and connection of external equipment to the unit. The connector types and their pin signals are described. Most of the connectors are located at the rear panel of the unit. For convenience, one USB port is located on the front of the unit to connect a mouse or memory device.

All the input/output ports are Safety Extra Low Voltage (SELV) circuits. SELV circuits should only be connected to other SELV circuits.

7.1 Keyboard connection (only DIVAR 5000 models)

Use the keyboard connection on the back of the unit to connect a Bosch Intuikey keyboard using one of the following methods:

- use the supplied RJ11 adaptor – see Connect using RJ11 adapter
- strip the keyboard cable (or equivalent cable) to connect leads directly – see Connect wires directly

For short distances (up to 30 m), standard 6-core telecom flat cable can be used to supply signal connections for the keyboard (LTC 8558/00). Always use the Keyboard Extension Kit (LTC 8557) for distances over 30 m between the keyboard and the DVR; this kit provides junction boxes and cables. Maximum cable length: 30 m (using standard 6-core telecom flat cable), or 1.5 km (using Belden 8760 or equivalent).

The appropriate power supply (11 - 12.6 VDC, maximum 400 mA) to externally power the keyboard must be purchased separately.

7.1.1 Connect using RJ11 adapter

Connect the adapter as follows:

- red cable to the (-) of the keyboard control connector
- green cable connects to the (+) of the keyboard control connector
- white cable to ground
- blue cable to +12V

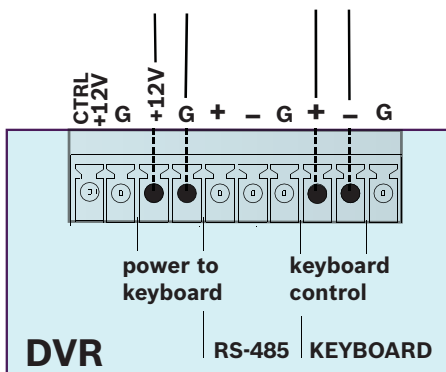
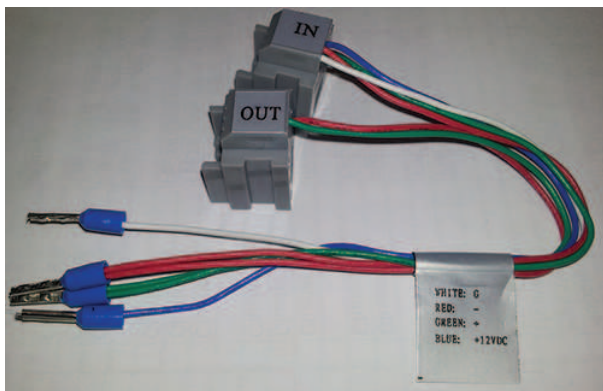

RS-485 only on hybrid models.

7.1.2 Connect wires directly

1. Cut off one of the connectors at the end of the cable.
2. Strip the cable wires.
3. Attach the stripped wires to the keyboard connector on the back of the DVR according to the illustration below.
4. Insert the attached cable connector into the DVR connector on the back of the keyboard.

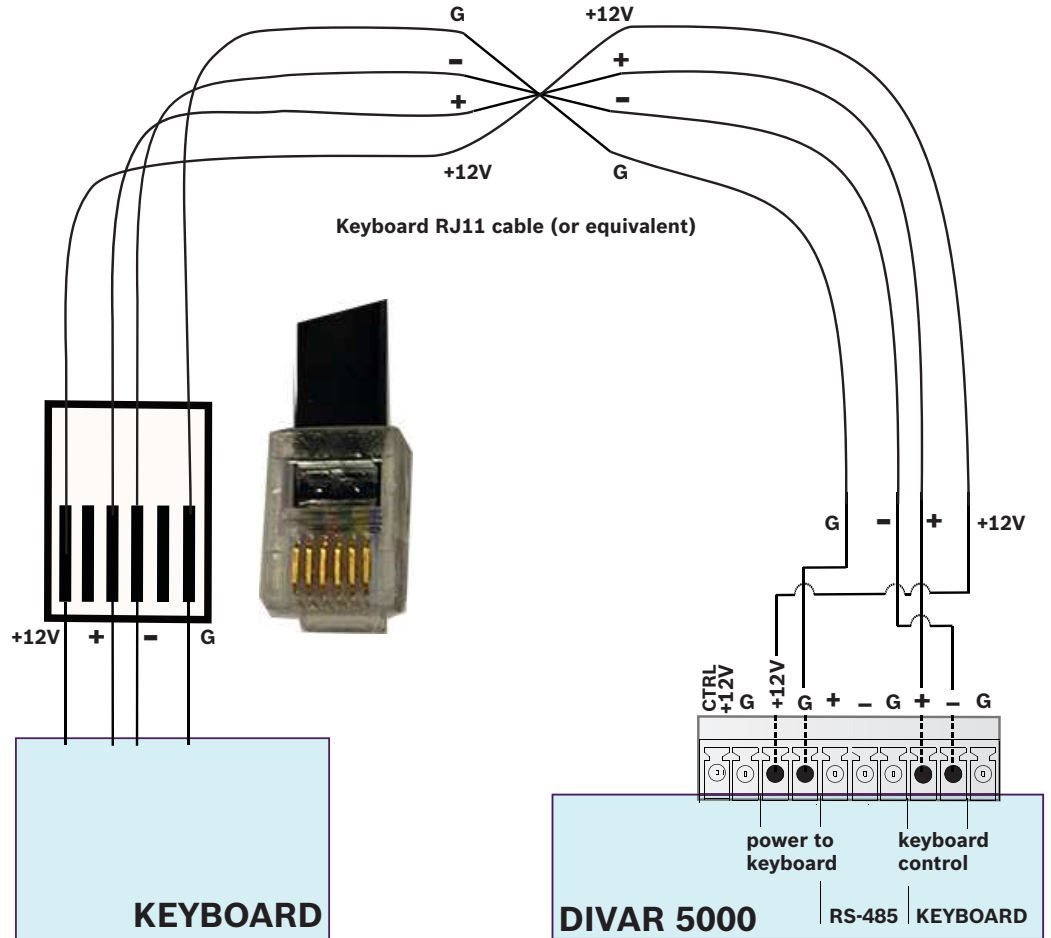

RS-485 only on hybrid models.

7.2 RS485 port connection (only hybrid models)

Use the RS485 connector to connect Bosch, Pelco-P or Pelco-D controllable cameras to the unit for pan, tilt, and zoom control. RS485 is a single-direction protocol; the PTZ device can't return any data to the unit.

Since RS485 is disabled by default for each camera, you must enable the PTZ settings as follows:

1. Connect a suitable cable to the RS485 connection on the DVR rear panel.
2. Connect the other end of the cable to the appropriate pins in the camera connector.
3. Follow the instructions in the Operation section of this manual to configure the camera for PTZ control.

The Bosch protocol is supported with the following baud settings:

- 9600 baud
- 8 data bits

- 1 stop bit
- no parity
- no flow control

+ - G

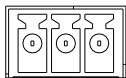

Figure 7.1: RS485 connector

Signal name	Pin number	Description
TX +	1	Data transmission
TX -	2	Data transmission
GND	3	Shield

Max. signal voltage is -8 to +12 V. The recommended cable cross section is AWG 28-16 (0.08-1.5 mm²).

7.3 RS232 port connections

The RS232 port can be used to connect different devices:

- Console
- PTZ Matrix - a pan and tilt control unit (using RS232 to Biphase converter)

The device type and required settings can be assigned in the menu (**Settings > System > Serial Port**).

Specifications

Connector type: 9-pole D-type male connector

Maximum input voltage: ±25 V

Communication protocol: Output signals according EIA/TIA-232-F



Figure 7.2: RS232 serial port

Signal name	Pin number	Description
DCD_in	1	Carrier detection signal (not used)
RX	2	RS232 receive signal
TX	3	RS232 transmit signal
N/C	4	No connection
System ground	5	System ground
N/C	6	No connection
RTS	7	RS232 request to send signal
CTS	8	RS232 clear to send signal
N/C	9	No connection

7.4 Alarm I/O connections

Alarm inputs and outputs are fitted as screw down terminal blocks on the unit. Cable cross section is AWG 26-16 (1.29 to 0.4 mm²).

DIVAR 2000/3000

1, 2, 3, 4	Alarm inputs: max. 4. The alarm becomes active at low voltage. Max. input voltage 15 VDC.
NO1 C1 , NO2 C2 ,	Two groups of normal open activation outputs (on/off button).
G	Ground cable.

DIVAR 5000

1, 2, 3, 4, 5, 6, 7, 8, 9, 10, 11, 12, 13, 14, 15, 16	Alarm inputs: max. 16. The alarm becomes active at low voltage.
NO1 C1, NO2 C2, NO3 C3, NO4 C4, NO5 C5	Groups of normal open activation alarm outputs (on/off button).
CTRL +12V	Control power output. Always close the device power to cancel the alarm.
+12V	External power output. Need the peripheral equipment to provide +12 V power (below 500 mA).
G	Ground cable.

8 Settings

8.1 System

Here you can choose from the following tabs **General, Playback, Display, Serial port, Account** and **Service**.

8.1.1 General

General

Language: Select here your desired language for the user interface.

Video standard: (only for hybrid models) Assign here your applicable video standard (PAL or NTSC) or use Auto-detect (default).

Device name: If required, assign here a unique identification name for this DVR.

Device no: Assign here an identification number (between 0 and 998) to be used by the remote control to control multiple DVRs.

Auto logout: Set here a time for automatic logout if a user is inactive for a period of time: 1 to 60 minutes (default is 'Never' - the user remains permanently logged on until logout or shutdown).

Export Type: Choose here the file type for exported files: DAV and/or ASF (default is both)

Show start-up wizard at next start-up: Select to force the user to assign settings requested by the Startup wizard after the next system restart.

Mouse sensitivity: Set here the mouse double-click speed required for selections.

Display logo: Activate or import a logo to appear automatically on the 'System login' and 'Playback disclaimer' screens. See below for how to import a logo.

Date & Time

System time: Click on the appropriate number to change it with the numeric keypad popup. The number format can be changed in the field below. The system is always started in default 24-hour mode. Select the correct GMT time zone. Click **<Save>** if you make any changes to the time.

Date format: Choose here between:

- YYYYMMDD (year month day) this is the default
- MMDDYYYY
- DDMMYYYY

Time format: Choose here between 12-hour and 24-hour.

Daylight saving time: Select checkbox to automatically set daylight saving in the DVR internal clock. Set the Start/End times for daylight saving by assigning the relevant times for the current year (assign 'Month'; the 'Week in the month' and the 'Day of the week').

NTP: Select checkbox to automatically synchronize the recorder internal clock using Network Time Protocol. If required, assign the **Server, Port** (default is 123) and synchronization **Interval** (default is 60 minutes).

Press **<Manual update>** to synchronize the time immediately.

IP camera time sync: Select checkbox to automatically synchronize the time in the IP cameras connected to the recorder. Assign a synchronize interval if required (default is 24 hours).

Logo import

The logo file must be:

- maximum 500 KB
- maximum 260 x 150 pixels
- 8 or 16 bits .BMP file format

Use the following steps to import a company logo:

1. Insert a USB stick (containing a company logo file) into the USB slot on the front of the DVR.
2. Choose the USB stick from the '**Device name**' drop-down menu (a list normally appears on the bottom half of the screen showing the current folders and files available on the memory device; if no device is shown, press **<Refresh>**).
3. Browse through the available folders and files before clicking on the required logo file in the list.
4. Press **<Import>** to add the logo.
5. Right-click the mouse to return to the **Display** screen.
6. Press **<Save>** to complete import of the logo.

8.1.2

Playback

Instant playback: Assign here the playback time for the preview function: 5 to 60 minutes (default is 5 minutes).

Show filelist: Select to allow the possibility to display a file list on the Search/Play screen (default is **no** show). Video is recorded in several small files on the hard disk. Each file has a maximum size of 60 minutes. Each recorded alarm event (e.g. motion alarm) will also trigger a new file. A specific file of video can be played by selecting the file from the file list. This functionality is mainly used to support in the analysis of a potential problem.

Show timeline selection: Choose here to show the timeline checkboxes (**All record, Normal, Alarm, Motion**) on the bottom of the search/play screen (default is **show**).

Playback disclaimer: Activate or setup a warning disclaimer dialog box to appear automatically before you can search or playback video recordings (or enter the 'Search/Play' screen). If the disclaimer is activated (default is deactivated), you must always press **<Accept>** before you can continue with search or playback. See description below for how to set up the Disclaimer:

1. Press **<Configure>** to open the Disclaimer screen.
2. Enter the required text in the text box using the alphanumeric keypad.
3. Press **<Save>** to save the text.

Note 1: Use **Default** to clear the current disclaimer text and de-select the Enable disclaimer setting (no disclaimer appears).

Note 2: The Playback Disclaimer text is language dependent; i.e. disclaimer text saved for the English language setting will not display for the Spanish setting.

8.1.3

Display

Use the Display menu to setup the appearance of your screen.

GUI

Resolution: Choose from the options: 3840×2160@60fps, 3840×2160@30fps, 1920×1080, 1280×1024 (default), 1280×720, 1024×768.

The system shows the selected resolution and requests a reboot, select OK within 10 seconds to apply. If cancel is selected or no actions are taken, the system reverts to the previous resolution.

Transparency: Adjust the menu transparency with the slider from 0 to 100% (default is 0 which is not transparent). This feature is only available in the network recorders and not in the hybrid recorders.

HDMI MON.B: De-select this option to turn off the monitor B output and save decoding power.

Display channel name in overlay (*): Selecting this option will show the channel name in the window overlay. The channel name however, will not be recorded in the video. Watching the video in Bosch tools (e.g. local playback, using the Bosch export player or the Bosch VMS like

BVC and BVMS) can still enable the overlay on the video. Exporting the video to a 3rd party format like AVI or MPEG however, will not show the channel overlay anymore. Use this option if you want to be able to dynamically turn the channel name on and off. Please note that all display options will always be applied to all cameras.

Display and store channel name in video (*): Selecting this option will record the channel name inside the video. This channel name will always be there, also when exporting the video to a 3rd party format like AVI or MPEG. It will not be possible to hide the channel name, also not in Bosch tooling. Use this option if you want the channel name to permanently become part of the video. Please note that all display options will always be applied to all cameras.

Camera name stamping: Choose the location of the camera name stamp: Top, Bottom or Custom (set by entering the X/Y coordinates).

Display time in overlay (*): Selecting this option will show the current time in the window overlay. This option is subject to the same conditions as "Display channel name in overlay".

Display and store time in video (*): Selecting this option to store the time in the video. This option is subject to the same conditions as "Display and store channel name in video".

Time stamping: Choose the location of the time stamp: Top, Bottom or Custom (set by entering the X/Y coordinates).

Display milliseconds (*): Select to show milliseconds on the time stamp.

Display system time: Select to show the general system time in the top right of the monitor.

Hide event and status indicator for covert cameras: Select to hide the indicators on covert cameras. Enabling this function hides the recording status icon as well as all potential alarm icons. Enabling this also means that it will not be possible in live mode to see if the camera is still recording or if any events occurred. Use this option to ensure that the covert window is completely black so that no one knows this camera exists.



Notice!

(*)

This configuration option is only available for Bosch cameras and not for 3rd party ONVIF cameras.

Views

The views menu can be used to modify the default lay-outs and create your own favorite views. It's possible to assign different cameras to views as well as to switch between the 1st and 2nd stream of the camera.

Using a system with a lot of cameras creates a high load on the performance of the system. Specifying the 2nd stream in multi-channel (such as 8CH/16CH) views may help reduce the stress on the system. In case the current camera set-up reaches its encoding limit (16 x 1080p), the system may run into a situation where channels can't display the video. For example, if there are eight 5MP cameras in the system, the system can't show all of them at the same time. Some windows will show an "out of decode" error message. Using the 2nd stream, which generally streams at a lower resolution, still allows you to display video of all eight cameras at the same time in live mode, while still recording the high quality 5MP streams.

Please note that a view can also be modified and saved directly from the live view using the quick menu and its assign camera and save view option.

View mode: The system has 6 different view modes (1, 4, 8, 9, 16 or 32 windows). For each mode, there are standard lay-outs. These standard lay-outs can be modified and new lay-outs can be created and saved.

Select **<Add>** to create a new view. A pop-up window allows you to configure the view: choose the view mode, enter a name and assign the 1st or 2nd stream of a camera to the selected view window in each drop down selector. Select **<Save>** to add the new view to the list or **<Cancel>** to leave the pop-up window.

Select a view with a check mark and select **<Edit>**, or simply double click the line of the view you want to edit.

Select a view with a check mark and select **** to delete the view.

Use **<Move up>** or **<Move Down>** to change the order of the views list.

Sequence A

Enable sequence monitor A: Activate or access the Sequence Mon. A menu to activate and setup the tour function (sequence of camera views). The sequence will automatically start when the system is in live view. To stop and start a camera sequence on Monitor A, use the Sequence on/off option on the Quick menu (right-click mouse button) or click the sequence button on the remote control or front panel (DIVAR 5000 only).

The other selections are:

- **Interval:** This value ranges from 5 (default) to 120 seconds.

Quick Config: Choose to quickly select default values for which view combinations are displayed (1, 4, 8, 9 and/or 16 windows) and which combination of cameras to use in the camera sequence.

If required, use **<Add>**, **<Delete>**, **<Move up>** or **<Move down>** to add or delete views, or to adjust the order of view settings.

Note 1: Use **Default** to select all camera sequences for all possible view types (the **Enable sequence** will be deactivated, and the **Interval** will be reset to 5 seconds).

Note 2: An enabled alarm/event will override a sequence and briefly display the event before returning to the sequence.

Note 3: The sequence menu is only able to work with the default views and can't use the new views created under the views tab.

Sequence B

Use the same procedure here to setup the live display sequence as used for Monitor A.

MON adjust

Adjust here the monitor output settings by dragging the slide bar for each item.

When ready, click **<OK>** to save changes and go back to the previous menu.

8.1.4

Serial port

Use the **Serial port** menu to configure the connections for a **Console** connected to the RS232 port, and an optional **Bosch keyboard (Intuikey series)** connected to the extra RS485 port (on DIVAR 5000 models). Configure the settings for **Console** or **Bosch keyboard** as described below.

RS232 serial port

Baud rate: from 1200 to 115200 (default)

Data bit: from 5 to 8 (default)

Stop bit: 1 (default) or 2

Parity: none/odd/even/space/mark (default is none)

Note: If the console connection to the RS232 port is not working, the RS232 port may already be selected for PTZ control – this is done in the **Camera > Configuration > PTZ** screen. If so, go first to this screen and reset the **Com connection** field to RS485.

Bosch keyboard

Baud rate: from 1200 to 115200 (default is 19200)

Data bit: from 5 to 8 (default)

Stop bit: 1/2 (default is 1)

Parity: none/odd/even/space/mark (default is none)

Keyboard address: (default is 1) One Intuikey keyboard can communicate with a maximum 16 DIVARs. If assigning multiple DIVARs to a keyboard, Set the **Keyboard address** for every DIVAR.

First camera offset: (default is 1) Set this offset for every DIVAR. Camera 1 of the DIVAR will be called on the keyboard by selecting the programmed '**First camera offset**' number. For example, set the offset to 101 so when you select 101, camera 1 is displayed in full screen on monitor A of that selected DIVAR. Press 112 to display camera 12 in full screen. Press **<Save>** to enter changes and go back to the previous menu.

8.1.5

Text/Pos (only on hybrid recorders)

With Text/Pos you can add text and information to the image. It includes information analysis and title overlay function. The **Sniffer mode** can be either COM (RS232) or NET (IP network).

Sniffer mode COM

For RS232 port settings see *Serial port, page 35*.

- **Overlay position:** Choose Top left, Bottom left, Top right, Bottom right.
- **Overlay mode:** Choose from:
 - Local – displays the overlay in the image in the local monitor video
 - Remote – stores/records the overlay in the recorded file
- **Overlay channel:** select the channel to add the overlay to.

Sniffer mode NET

- **Overlay position:** Choose Top left, Bottom left, Top right, Bottom right.
- **Overlay mode:** Choose from:
 - Local – displays the overlay in the image in the local monitor video
 - Remote – stores/records the overlay in the recorded file
- **Bridge id:** Choose an ID from 1 to 16. Under each ID you make these selections:
 - Bridge ip: select the destination ports. If required, you can change the corresponding Service port number
 - Host ip: select the destination ports. If required, you can change the corresponding Recorder port number
 - ATM/POS import: select 1 of the 4 imports.
 - Overlay channel: select the channel to add the overlay to. You can use each channel only once.

8.1.6

Account

This screen lists all of the user accounts for this recorder. Each account level is set with individual user rights and limited by a password. If you have 'administrator' rights, you can **add**, **delete** and **modify** user account (except your own) - see descriptions below. Use **<Move up>** and **<Move down>** to change the order in which the users appear in the 'Accounts' (this also determines the order of users in the Login menu).

Add user

Select **<Add user>**.

1. Enter a **User name** up to 16 characters.
2. Enter a **Password** and **Confirm password** by entering it again.
The password should at least:

- contain a minimum of 8 characters
 - use both uppercase and lowercase characters
 - include one or more numerical digits
 - include one or more special characters (! ? # \$ % = + * -)
3. If required, enter a security question and answer to help prompt the password if you forget it later.
 4. Manually select the authority fields required for the new user type for all tabs (System, Live, Playback).
 5. Select **<Save>** when done.

Delete

Delete an Account as follows:

1. Click **<X>** in the 'Delete' column for the Account to be deleted
2. Confirm the delete by clicking **<Yes>**.

Modify an account password (or security question)

1. Select the pencil icon beside the relevant **Account name** on the list (a new screen appears with selection fields for changing password and user authorities).
2. Select **Modify password**.
3. Enter the **Old password**.
4. Enter the **New password**.
5. Enter the new password again in the **Confirm password** field.
6. If required, enter a new **Question** and **Answer** for the password security field: Choose a question from the pull-down list (or enter your own customized question). Enter the appropriate answer.
7. Click **<Save>** to save the new password settings.

Modify account authority

1. Select the pencil icon beside the relevant **Account name** on the list (a new screen appears with selection fields for changing password and user authorities).
2. Change the user authority by (de)selecting the check boxes.
3. Click **<Save>**.

8.1.7

Service

Upgrade firmware

Upgrade the system firmware in 2 ways:

Via the Bosch download store (an open internet connection is required):

1. View the current firmware version of your installed system
2. Check the Bosch download store if new versions are available
3. Upgrade to a new version if required.

Via the USB slot:

1. Insert a USB stick with a preloaded update file (must be called **xxx.bin**).
2. Click **<Upgrade>**.
3. Select the update file.
4. Click **<Start>** to begin the update.
5. Wait until the update is complete and the system is restarted.

**Notice!**

Bosch strongly recommends upgrading to the latest firmware for the best possible functionality, compatibility, performance and security.

Check <http://downloadstore.boschsecurity.com/> regularly to see if there is a new firmware version available.

Config

Here you can import or export (backup) configuration settings:

Import

1. Choose a memory device from the drop-down menu (a list normally appears of previously saved system settings available on the device).
2. Select the required config files from the list.
3. Click **<Import>** to load the files.

Export

1. Choose the device to export to.
2. Check there is sufficient space on the device.
3. Use the selection buttons (on the bottom of the screen) for your configuration backup:
 - **New folder** will create a new folder on the selected memory device
 - **Format** will ask to confirm a format of the selected memory device.
 - **Import configuration**
 - **Export configuration** saves a copy of the system settings to a selected memory device

Default**Notice!**

User settings and recordings will be lost

The system menu display, language, time display mode, video format, IP address and recordings will all lose their user defined setup after the factory defaults are restored.

Reset menu defaults

Use this option to restore specific parts of the configuration to defaults. This option will only reset the corresponding settings for the selected menu to its default settings.

1. Select the check boxes for the menus you wish to reset.
2. Click **<Save>** or **<Apply>**.

Reset complete system to factory defaults<Save>

Use this option to reset the complete device to factory defaults. Please note that this will also delete all recordings and remove any loaded certificates from the system.

1. Click **<Reset>** (you may need to enter a Password to confirm the restore).

8.2 Network

8.2.1 Connection

Four extra tabs are available (**External, Internal, Port, Streaming**).

In a typical installation the external and internal network are clearly divided. IP cameras are connected to the internal network and/or PoE ports of the recorder which makes them isolated from the rest of the network/internet. The external network port is then used to connect the recorder to the general network or public internet. Of course there may be good reasons to differentiate in the network setup.

In any network setup, it is important to note that the external and internal network of the recorder are not internally connected / looped-through. This means these are really two separate networks which can't communicate directly with each other. It's therefore mandatory that the external and internal network must fall into a different IP range / subnet if both of them are used. Without this separation the recorder would not know to which network connection to send any incoming traffic.

External

Input here the following information for connecting the recorder to a public outside network:

MTU: Maximum transmission unit in bytes unit for used ports (default is 1500).

IP version: IPv4 (default) or IPv6. This is the IP address access format.

DHCP (only for IPv4 option): Select this to automatically search for IP details. If this field is enabled, you cannot modify IP / Subnet mask / Gateway and these values are displayed as zero (if PPPoE is operating, you also cannot modify IP/Subnet mask /Gateway). To view the current IP information, you first need to disable the DHCP function.

Link address (only for IPv6 option): Network address that is valid only for communications within the network segment (link) or the broadcast domain that the host is connected to.

IP address: Enter here your IP address. (For the IPv6 version, default gateway, preferred DNS and alternate DNS, the default value shall be 64-digit).

Subnet mask (only for IPv4 option): Enter here your subnet mask address

Default gateway: If required, enter here the default gateway address.

Notice!

Addresses and maximum connections

The system needs to check the validity of all IPv6 addresses. The IP address and the default gateway must be the same in each IP section (i.e. the specified length of the subnet prefix must have the same string). The maximum number of connections is 64, however the bandwidth is limited. Bosch strongly advises not using more than 4 simultaneous connections streaming video at the same time.

Preferred DNS: if required, enter here the preferred DNS server IP address.

Alternate DNS: if required, enter here an alternative DNS server address.

When ready, click **<Save>** to enter values and go back to the previous menu.

Internal

Choose here the settings for connecting cameras to the recorder in a closed internal network (DHCP or as a DHCP switch).



Using the **DHCP** option, the recorder will act as a normal network device. The IP can be configured manually or an IP address will be automatically assigned by a DHCP server if the DHCP checkbox is ticked. This option is normally used for devices where the recorder and cameras are in a separate internal network and the IP allocation is arranged outside of the recorder.

With **Use this device as a DHCP switch** selected, the recorder will function as a DHCP server. This means the recorder will assign an IP address to any device that is connected to its network. This option is generally used when the cameras are connected to the PoE ports of the recorder or when the recorder is expected to manage the IP addresses in the internal network.

Both options have the same settings. Please note that for the DHCP server option, the IP addresses will be assigned in the IP address range specified in this section.

IP address: Enter here your IP address.

Subnet mask: (only for IPv4 option): Enter here your subnet mask address

Default gateway: If required, enter here the default gateway address.

Port

Go to your router that connects your recorder to the internet and forward these communication ports: HTTPS, RTSP and TCP. If you plan to connect through HTTP as well, forward the HTTP port in your router. **Bosch advises to use only HTTPS connections for a higher security.** Read your router manual for instructions to forward ports to a device.

TCP port: Default is 37777. This port is used by the Bosch DIVAR Mobile Viewer to connect to the recorder with mobile phones.

UDP port: Default is 37778.

HTTP port: Default is 80. This port can be disabled to prevent any remote access to the recorder through HTTP traffic. Allowing only HTTPS connections to the recorder grants a much stronger security and Bosch strongly recommends to only use HTTPS communication. However, if the network bandwidth is limited, the system has a very high load (e.g. 32 connected cameras) or the remote workstations are not powerful enough, the HTTP connection can be used to increase the systems performance and reduce network bandwidth stress.

HTTPS port: Default is 443.

RTSP port: (Default is 554). When setting up RTSP streaming, use the following URL format:

rtsp://<username>:<password>@<ip>:<port>/cam/realmonitor?

channel=<channelNo>&subtype=<typeNo>

e.g.: rtsp://ADMINISTRATOR:000000@10.120.19.60/cam/realmonitor?channel=1&subtype=0

username = username

password = password

port = default is 554 (this is optional)

channel = channel number 1..16

subtype = 0 or 1 (1st or 2nd stream)



Notice!

Reboot

The system always needs to reboot if any of the above ports are changed. Make sure the port values here do not conflict.

Streaming

Choose your preferred **Live Video Stream Buffering:**

- Realtime
- Balanced
- Network optimized
- Custom - set here your preferred streaming buffer (minimum 200 ms, maximum 2000 ms, default 500 ms)

The buffer size increases from 'Realtime' to 'Balanced' to 'Network optimized'. 'Realtime' uses a minimum buffer to minimize latency. If your video stream has a high bit-rate, the video may not run smooth in live mode. To get a smoother video, you can increase the buffer by selecting 'Balanced' or 'Network optimized'. But this will increase the latency. In general, Bosch recommends to use the network optimized option to guarantee a fluent stream. However, if PTZ cameras are installed and frequently operated, it's better to use the 'Realtime' mode to ensure a smooth control of the domes.

Please note that these settings only apply to the recorders local live mode. The settings have no impact on the recorded video or on remote live streaming. If there are issues with fluent remote live streams, consider using the 2nd stream with lower bandwidth requirements.

8.2.2

DDNS

Make sure the recorder is connected to the open internet, before you configure the DDNS service.

Use these steps to configure DDNS:

1. Select the 'Enable' box.
2. Select DDNS provider(s) from the drop-down menu. More DDNS types can be used at the same time; you only need to select the required type. These providers are supported:
 - Bosch remote portal (see Notice)
 - NO-IP DDNS
 - Dyndns DDNS

Notice!

Bosch remote portal

The Bosch remote portal is a free DDNS service by Bosch. You can apply for an account if you select "Bosch Remote Portal" in the DDNS menu on the recorder, and fill in the boxes as described below this notice. Use a valid email address to apply for this. After this application, the email address is the account name for your DDNS service. You can use multiple recorders on the same account. Just fill in on each recorder your email address in the <Account> box, your password and use different domain names for each recorder.

Your DDNS registration is activated immediately, but needs email confirmation. To confirm your DDNS registration, click on the link in the email you receive. If you do not confirm the account, the DDNS registration is cancelled.



If you select Bosch remote portal:

1. Fill in the details for the unique Domain name you want to use. *Your domain name is a subdomain below boschremotecomnect.com. If the device is correctly connected to the internet, the dropdown box shows the available subdomain name (e.g. boschremotecomnect.com)*
2. Fill in a valid email address in the <Account> box and a correct password. Your account is your email address. See Notice above.
 - If you already have an account, use the information from this account.
 - If you create a new account, you must choose a new password. Use a strong password! Confirm the password in the next field.

3. Select the 'I agree to ...' boxes after you read and approved the terms and conditions and privacy statement.
4. Click **<Apply>** to register your domain name
5. You can use your domain name immediately. If you created a new account, you must confirm your DDNS registration by clicking the validation link in the email you receive. After registration, you can manage your DDNS accounts on <https://remote.boschsecurity.com>

If you select another DDNS provider:

1. Fill in the details for the Domain as assigned by the provider.
2. Fill in your user name and password.
3. In the "Interval" box, fill in the interval time between the updates of your IP address to the DDNS provider.

8.2.3

Mobile

Use this page to scan the relevant QR codes for downloading the IOS or Android apps for operating your DIVAR. Once the app is downloaded, scan the relevant QR code to add the device through its Local IP (if connected to a WiFi network) or remote IP / DDNS name (if connected to the public internet).

8.2.4

Bandwidth

Use this option if the external connection of the recorder is connected to a limited network bandwidth. A typical use case can be to restrict the bandwidth the recorder may use to control the stress on the network and prevent the recorder absorbing all available network bandwidth and preventing other systems from working.

Apart from ensuring that the bandwidth will not exceed the configured value, the remote clients will also behave differently. BVC for example will always request the 2nd stream by default in live mode and the playback will only stream I-Frames only (1 picture every second) on half speed to reduce the network stress. Setting the remote client in pause mode will load all frames for watching the complete video. Of course exporting the video will always export all frames as well.

- **Bandwidth limit speed:** Default is No (there is no bandwidth limit active)
The bandwidth limits the traffic from the DVR to each client where each connection individually may not exceed the configured bandwidth. If bandwidth is set to a value, the default bandwidth limit **only** applies to network connections outside the subnet of the DVR (WAN). Bandwidth limit does **NOT** apply to network connection on the same subnet as the DVR (LAN).

Note: IP addresses starting in the range of 10.0.0.0 to 10.255.255.255, and 172.16.0.0 to 172.31.255.255, and 192.168.0.0 to 192.168.255.255 are always considered LAN addresses.

The default settings can be overruled by using the **<Add>** button to add IP address ranges in **'Subnet never limited'** or in **'Subnet always limited'** (it is not possible to enter the same IP address in both fields). Select a checkbox in front of an IP address and press **<Delete>** to remove an IP range from the list; use **<Default> to return all default settings**. When ready, click **<Save>** to save settings and return to previous menu.

DVR will check automatically if a BVC or Web Client network connection request is sent from a PC located in the field **'Subnet never limited'** or in **'Subnet always limited'**.

This means that, when the bandwidth limitation is active, it will be limited to the selected bandwidth setting. For example, if bandwidth limitation is set to 256 Kbps, then network

traffic to these limited IP connections will not exceed 256 Kbps.

When the bandwidth limit is set to a value, the encoding settings for the 2nd stream will be optimized to stream live video for the selected bandwidth value - see below.

- **Bandwidth limit clients:** Default is 1.
Choose here the number of 'bandwidth-limited' clients (max. 4) that are allowed in the bandwidth limit configuration. Every 'bandwidth-limited' connection used is maximized to the configured maximum. For example if max bandwidth usage is set to 256Kbps and the 'bandwidth-limited' clients value is 4, then the total bandwidth consumption can be 1M. A maximum 64 'remote' client connections are possible, however more than 4 remote clients can lead to performance limitations. If the maximum available bandwidth for streaming is used (60Mbit/s) - users can still login, but will not receive a video stream until bandwidth is available again

8.2.5 UPnP

This protocol enables a mapping relationship between the LAN and the WAN:

- Enable or disable the UPnP function on this device
- Status – Can be Disable, Success, Searching or Unknown (when the system is offline)
- Router LAN IP
- Router WAN IP

The bottom table shows the PAT (port mapping list) with a one-to-one relationship with the router port mapping setting:

1. Double-click a port to change a setting
2. Click **<OK>** when ready.

8.2.6 PPPoE

Enable or disable the PPPoE feature.

Enter your PPPoE '**User name**', '**Password**' and **IP address** supplied by your internet service provider, and click **<Apply>**.

You will need to restart your system to automatically connect to the internet (the IP address will be automatically assigned).

8.2.7 SNMP

SNMP (Simple Network Management Protocol) provides the basic network management frame of the network management system, and can be used to retrieve basic system health information. It can also be used to configure the system to send out traps for events such as system reboot, video loss, hard disk errors, etc.

The SNMP files can be retrieved/received on devices using common tools such as MG-SOFT MIB Browser. The Management Information Base (MIB) can be downloaded via the Web.

Use the following steps to configure SNMP:

1. Select the 'SNMP enable' box.
2. Use the defaults for 'SNMP port', 'Read community', 'Write community', or assign your settings if required.
3. To set up traps, press **<Add>** and enter IP addresses and ports of the devices that should receive the trap notification. Press **<Delete>** to delete a device from the list.
4. Use the defaults or assign settings for 'Video loss' events sent to the trap:
 - Single mode (set a time limit for detecting a single video loss to generate the trap)

- Multi mode (set the number of video losses which should occur within a set time to generate the trap)

8.2.8

Email

Use this screen for the email settings (address, sender, etc.) if you have enabled the field 'Send email' in the menus Alarm, Detect and System events.

See the following descriptions for the field settings in this screen:

SMTP Server

Set to the mail server that processes outgoing e-mail for your network. This can be either an IP address or a Fully Qualified Domain Name (ex. 10.0.0.1 or smtp.example.com)

SMTP Port Number

This is the port the mail server receives e-mail on. The internet standard for e-mail is port 25, but some servers use different ports to protect against being used to transmit bulk, unsolicited e-mail.

User name and Password

If authentication is required, regardless of encryption, enter the User name and Password provided by your administrator in each field respectively.

Anonymous

Select this option to hide the sender details.

Receiver

Enter up to three e-mail addresses that outgoing e-mail should be sent to.

Fixed domain

This field restricts the email addresses that can be used in the receiver field to email addresses of the entered domain only.

Sender

This is the e-mail address that will appear as the sender of all e-mail originating from the unit.

Subject

This is the subject that will appear in all e-mail sent by the unit.

Encrypt type

Some mail servers require encryption to transmit e-mail. If required, use SSL or TLS encryption when sending e-mail. If not required, select 'NONE'.

Attachment

Check this box to allow an attachment to email.

Health status update

Check this box to command the system to send out a test email to check the connection is OK. This will be done at the regular interval set in the **Hour** field. A dialog box will appear to display if the connection is OK or not.

Another option is to click **<Test>** to manually check the email connection.

8.2.9

Storage

First boot up the corresponding FTP server before activating this menu.

1. Select the File format and type of recording.
2. Choose a location (FTP server, a SMB file server or an eSata disk). Use **<Configure>** to setup the location.

3. Assign a schedule for the backup (weekday, start time, last number of days, time period and which channels to backup). You can start the backup once a week or multiple times per week.
4. Select **<Apply>** or **<Save>**.

When a backup is running, the backup progress is displayed in a progress bar.

See also

- *Recording, page 47*

8.2.10

IP filter

The system supports IPv4 and IPv6 address format.

Choose for access to 'Trusted' or 'Blocked' sites IP addresses. If you disable this function, all IP addresses can access the current DVR.

Enable or disable the feature and then use **<Add>** to select IP address, IP section and MAC address. Press **<OK>** to confirm.

8.2.11

Certificates

8.3 Camera

8.3.1 Detection

This page is used to find cameras on the network and assign them to the recorder.

Device search

This screen shows a list of IP cameras connected to the same network as the DIVAR. IP cameras connected to the PoE ports will not show up in the device search as they are already automatically added to the device list.

1. Click **<Device Search>** to search for any newly connected cameras.
2. Select the required cameras in the Search list and add to Device list by clicking **<Add>** (or by double clicking on the camera).
3. Selected cameras appear in the Device list.
4. A camera can also be added with the **<Manual add>** button in case the camera can't be found in the device search.

If a PoE camera is not automatically added to the device list, disable the check box **Automatically assign PoE cameras**. If a switch is connected to one of the PoE ports the setting must be disabled. In this case, the cameras must be found and added through the device search.

Device list

The device list shows the list of channels with their assigned cameras.

For each camera in the device list the status is shown with the following icons:

- Green light ONLINE, red light OFFLINE
- Green lock AUTHENTICATED, red lock LOCKED

Select one or more channels to **Authenticate**, **Modify** or **Delete** the channel(s) by selecting the appropriate function:

Authenticate is used to login to one camera, or multiple cameras with the same username and password. For all Bosch cameras, a username and password is required to use the camera. Selecting **Authenticate** for this camera will request to specify the initial username (default: service) and password.

Modify can be used after a camera is authenticated and is used for assigning the camera to a different channel or to change the cameras name. The **Modify** button can also be used to change the network settings of the camera. The "Configure network addresses" screen appears where, if the DHCP checkbox is deselected, the IP address and other network settings can be changed. After making changes selecting **Modify** opens a confirmation dialogue box. To confirm select **Yes**, this will cause the modified cameras to be rebooted.

Notice!

Using modify on multiple cameras at the same time

This provides the option to configure the IP address of all cameras to a specific network range. Use this option with care, as assigning the cameras to a network range which is different than the internal or external network range will lead to a situation where the cameras will no longer be accessible by the recorder. A warning message is shown if this action is used to prevent accidentally using this feature.

Delete is used to delete one or multiple cameras from the device list.

8.3.2 Configuration

General

Assign here for each channel the camera identification fields.



Overlay

Privacy masks (*): Select <Record privacy masks> if you want the overlay to be recorded or <Live display only> if the overlay should not be present in the recorded video.

To set the mask area:

1. Select the required mask <1>, <2>, <3> or <4> from the **Configure mask** pull-down menu.
2. Select the **Enabled** checkbox.
3. Use the mouse to drag a mask over the area to be concealed. Enlarge or shrink the mask as required.
4. Select and drag a new area as required (system supports max 4 masks per channel).



Notice!

(*)

This configuration option is only available for Bosch cameras and not for 3rd party ONVIF cameras.

PTZ

Choose a camera channel.

PTZ type: For IP cameras: choose None or Remote. For analog cameras: choose None, RS232 or RS485.

RS232 or RS485 selection

Select:

- **Bilinx checkbox** for PTZ cameras connected via a Bilinx convertor
- **Protocol:** Bosch, Pelco-D or Pelco-P
- **Baud rate:** from 1200 to 115200 (default is 9600)
- **Data bit:** from 5 to 8 (default)
- **Stop bit:** 1 (default) or 2
- **Parity:** none/odd/even/space/mark (default is none)

See description below for how to use the **<Copy>** function.

After completing setup, click **<Save>** to store the PTZ setting and go back to the previous menu.

For a detailed description of how the PTZ is operated, see section Operation.

Copy

The Copy function allows you to quickly copy one PTZ channel setup to more channels (or all channels). This obviously saves repeating common settings for each channel.

For example:

1. After setting values for channel 1, click **<Copy>** to go to the **Copy** screen.
2. Check the currently copied channel name is highlighted (for example, channel 1).
3. Now select the channel(s) to paste to, e.g. channel 5, 6 and 7. (If you want to save the current setup of channel 1 to all channels, click the box **All**.)
4. Click <OK> to save the copied setup.

8.3.3

Recording

Use the recording page to configure the settings of the camera stream that will be recorded. The higher the recording settings, the higher the quality of the recorded video stream. The downside of a high quality video stream is that the stream will use more storage capacity and the disk will get full sooner. Another disadvantage is that high quality video streams use a higher network bandwidth and therefore create a higher stress on the systems performance and remote network.

There are 3 different recording modes: Regular, Motion and Alarm. Regular recording is the default mode and IP cameras will follow the same settings in live mode as the regular recording settings. (For example: if the regular recording is configured to 1 fps, then the live video will also only be at 1 fps).

The motion and alarm events allow the option to use different recording settings when events happen. These are typically used to record at high quality settings when something happens, while the regular recording is at a lower quality setting to save storage capacity. There are also different options for the 1st and 2nd stream recording.

For analog cameras:

- Live video will always be 30 fps on full quality regardless of the recording settings.
- In the recording settings it's possible to configure the resolution, framerate, bitrate type, bitrate, record audio and audio encoding.

For 3rd party IP cameras (ONVIF):

- Live video will be the same as the recording settings of the regular settings.
- In the recording settings it's possible to configure the resolution, framerate, I-frame distance and bitrate.

For Bosch cameras:

- Live video will be the same as the recording settings of the regular settings.
- In the recording settings it's possible to configure different settings through profiles, described here below.

Resolution

Select here the resolution for Stream 1 and Stream 2 in the Regular tab only, the same resolution is then used for Motion and Alarm.

Selecting a resolution in Stream 1 may change the possible options in Stream 2, so when Stream 1 is changed Stream 2 must be re-aligned.

Profile (*)

Bosch cameras have 8 different default streaming profiles which are tuned for different use-cases. The settings for each profile will differ per camera model. Switching between a profile will load the new settings which belong to that profile (Frame rate, I-frame distance, Target bit rate, Maximum bit rate and Bit rate optimization) connected to that profile. The settings can be changed and when saved these settings are stored within the selected profile.

- **Profile 1**
Image optimized for the highest quality. This profile has its settings optimized for the highest possible quality, ignoring any bandwidth limitations. Use this option if the image quality is the most important and there are no storage requirements and network bandwidth is no concern.
- **Profile 2**
Balanced mode for a high quality stream. This profile has the best balance for a high quality stream while keeping the bandwidth and thus storage requirements at a reasonable level.
- **Profile 3**
Bit-rate optimized. This profile is optimized for the best possible bitrate and storage requirement, while still keeping the stream at an acceptable quality level.
- **Profile 4**
Standard resolution for high bandwidth connections. This profile is intended to be used if the camera is configured into standard resolution mode, where profile 4 is used to optimize the image quality of the SD resolution.
- **Profile 5**
Standard resolution with lower data rate. The same as profile 2 but for SD Resolutions.

- **Profile 6**
Standard resolution for low bandwidth connections. The same as profile 3 but for SD resolutions.
- **Profile 7**
Standard resolution for DSL connections. This profile really reduces the bitrate of the camera streams to ensure the image can be transferred over limited network connections. Noticeable reduction of image quality can be observed in the picture. This profile should be used on low bandwidth networks or on the 2nd stream for remote networks.
- **Profile 8**
Low resolution for mobile phone connections. This profile is specifically created for very low bandwidth connections. As a result, the image quality will be poor. This profile is normally used for the 2nd stream if remote connections through the 3G/4G network is commonly used through the mobile app.

Each recording mode has a 1st and 2nd stream option. The resolution can only be configured for the regular recording and automatically applies to all recording modes. The profiles (and thus all settings belonging to a profile) can be different for each recording mode.

Please note that all recording modes share the same set of profiles. (for example if you assign profile 2 to both regular and motion recording - and you would then modify the settings of profile 2 under motion recording, this automatically also changes the settings for regular recording). In a typical use case, the assigned profile and its settings are the same for all recording modes to have a controlled storage and bandwidth usage. A different typical use case, is that events will use different settings. In this case, a different profile for each recording mode should be used.

The regular recording mode always defines the quality and framerate of the live video stream.



Notice!

(*)

This configuration option is only available for Bosch cameras and not for 3rd party ONVIF cameras.

Frame rate

Select the appropriate frame rate (in frames per second).

I-frame distance

Select the I-frame distance by choosing the number of frames from 2 to 60 which indicates after how many images an I-frame is generated. The lower the number, the more I-frames, causing higher bandwidth and storage requirements, but also a higher image quality. For most cases, this setting is best used at its default value.

Target bit rate

To optimize use of the bandwidth in the network, limit the data rate for the device. The target data rate should be set according to the desired picture quality for typical scenes with no excessive motion.

For complex images or frequent changes of image content due to frequent movements, this limit can temporarily be exceeded up to the value entered in the **Maximum bit rate** field.

If the entered value is too high or too low the nearest possible value is chosen.

Maximum bit rate

The encoder maintains the maximum bit rate over a number of GOPs (group-of-pictures), limiting image quality when necessary.

The value entered in this field must be at least 10% higher than the value entered in the field **Target bit rate**.

Bit rate optimization

Use this option instead of the target/maximum bitrate to use predefined configurations to optimize the bit rate settings.

Select the appropriate rate for bit rate optimization. Options are Off, Maximum quality, High quality, Medium (default), Low bit rate, Minimum bit rate. If the camera does not support Bit rate optimization only Off is displayed.

NOTE: The profile settings are stored locally in the recorder. In case the camera settings are changed directly in the camera, these settings will later be overwritten by the recorder again. To configure the camera completely in the WEB interface, there are 2 options:

- Finish the complete camera configuration before adding the camera to the recorder.
- Press the retrieve button in the recording settings screen after the modifications in the camera are complete to obtain the recent camera configurations and then save this to the recorders configuration.

8.3.4

Installer

General (*)

Application variant: if the camera supports different application variants this option will be shown. To change this setting select the required application variant in the drop down menu. Changing the application variant will reboot the camera in the new mode and default the camera settings (except IP address, subnet mask and IP assignment setting) to factory default.

Base frame rate: this option allows you to select the base frame rate that the camera uses to transmit video. Depending on the option selected the options in the Frame rate field in the **Camera > Recording** menu will change. Choosing between 25 or 30 frames per second for PAL/NTSC is a common selection here.

Coding standard: if the camera supports different coding standards this option will be shown. Select the required encoding standard, H.264, H.265 or H.265 with no B-Frames.

Image rotation: select the required angle to output the correct image orientation.

Mirror Image: select On to output a mirror of the camera picture.

Making changes to Base frame rate, Coding standard, Image rotation or Mirror image apply immediately and do not require selecting the **<Apply>** or **<Save>** button.

Lens Wizard (*)

This page enables you to focus the lens on a particular area. In the preview window, use the mouse to change the size and position of the outline box that defines the focus area.

For cameras with optical zoom: click **Default** to set the lens to its default position. Use the slider to adjust the optical zoom of the lens.

For cameras with motorized back focus: click **Center** to set back focus to center position.

To autofocus the lens click either **Full** or **Local** range. The motorized automatic back focus process runs through either the full range or the local range. The focus position, state and indicator are shown.

The lens type is displayed; if required, select the Iris type.

Check the IR-corrected lens box to have the same focus positions for day and night.

To adjust the focus position separately for day and night uncheck the IR-corrected lens box.

The relevant focus position slider is activated. During the day, a focus position for day can be configured. When it becomes dark and the camera switches to night (monochrome) mode, a focus position for night mode can be configured. To manually configure the day and night

focus position at any time of the day, the camera mode can be temporarily switched using the **Switch** option. Both focus positions can be configured during Day and Night in this way. After leaving the menu, the recorder will automatically return the camera back to its original mode.

**Notice!**

(*)

This configuration option is only available for Bosch cameras and not for 3rd party ONVIF cameras.

8.3.5**Maintenance****Import/export configuration (*)**

Save configuration data for the device to a USB drive and load saved configuration data from a USB drive to the device.

To load configuration data from the USB drive to the device:

1. Click **Import**; a dialog box appears.
2. Fill in the configuration password.
3. Locate and open the desired configuration file.

Make certain that the file to be loaded comes from the same device type as the device to be reconfigured.

The progress bar allows monitoring of the transfer.

To save the camera settings:

1. Click **Export**; a dialog box appears.
2. Provide a password to protect the configuration file and confirm it.
3. Select a location on the USB drive, create a **New folder** if required.
4. Click **Export**.

Update firmware (*)

The camera functions and parameters can be updated by uploading new firmware. To do this, the latest firmware package is transferred to the device via the network. The firmware is installed there automatically. Thus, a camera can be serviced and updated remotely without requiring a technician to make changes to the device on site. The latest firmware can be obtained from your customer service center or from the download area.

**Notice!**

Before starting a firmware update, make sure to select the correct upload file.

Do not interrupt the firmware installation. Even changing to another page can lead to an interruption.

Uploading the wrong files or interrupting the upload can result in the device no longer being addressable, requiring it to be replaced.

To update the firmware:

1. First, store the firmware file on your USB drive.
2. Enter the full path for the firmware file in the field or click **Browse** to locate and select the file.
3. Click **Upload** to begin transferring the file to the device. The progress bar allows monitoring of the transfer.

The new firmware is unpacked and the Flash memory is reprogrammed. When the upload is completed successfully, the device reboots automatically.

Restart camera(s) (*)

To restart the camera:

1. Select one or more cameras that require restart.
2. Click **Restart**; a dialog box appears.
3. To restart the camera click **Yes**, to cancel click **No**.

Restore factory defaults (*)

To reset the camera to factory default:

1. Select one or more cameras that require reset.
2. Click **Default**; a dialog box appears.
3. To reset the camera click **Yes**, to cancel click **No**.

**Notice!**

(*)

This configuration option is only available for Bosch cameras and not for 3rd party ONVIF cameras.

8.3.6**Channel type****Channel type (only for hybrid recorders)**

This recorder has 32 channels. For the first 16 channels you can choose between analog or IP. The first 16 channels are analog by default.

To change from analog to IP: always start with channel 16, then channel 15, etcetera. You cannot change a random channel. Always select the adjacent lower channel.

8.4 Alarm

Use the **Alarm** menu to specify the desired behavior for a Motion detect, Video loss, Input alarm, System alarm, or Alarm out; also define how alarms are acknowledged.

8.4.1 Motion detect

Here you can set events that can be used to trigger motion detection alarms.

Channel: Recording mode will be activated for the selected channels if the event occurs (make sure you have selected “Motion” for the corresponding cameras in **Main Menu > Setting > Schedule to actually allow motion recording**).

Enable: Select to enable motion detection from the camera.

Period: Click **<Set>** for a new interface screen where you can organize time periods for detect activation as follows:

1. Select the check box on the left for the day where you require detection (or ‘All’ for all days).
2. If you do not require motion detection for the whole day, hold down the left mouse button and drag it over segments of the time bar to assign begin and end times for deactivating motion detection (the default is a colored bar for 24-hour detection). Use the **<Set>** button to assign precise deactivate times if required.
3. When you have correctly assigned a day, continue with the next day. If the time periods are the same as the first day, then a quick way to do this is:
 - click **<Set>** for the time bar to copy
 - Under the ‘Copy’ line, select each of the days that have a similar setup (checkbox is ticked) and click **<Save>**. Use ‘All’ to select all days.
 - the same time periods for the first day now apply to all selected days
4. When ready, click **<OK>** to return to the Alarm or Detect screen. Do not forget to click **<Save>** here to save your settings.

De-bounce time: Set here a timer for how long the detect alert should stay active after it is first activated (default is 5 seconds). During this time, the system will activate the alarm display, alarm output, tour, PTZ, snapshot, channel recording and buzzer (if they are all selected). An alarm upload and email will also be sent (if selected). If a new alarm is detected within the De-bounce time, the timer will be reset for the alarm display, alarm output, tour, PTZ, snapshot, channel recording and buzzer (no new alarm upload or email are sent).

Delay: Defines the minimum time the channel recording remains active after the event has ended. Set here an extra timer for channel recording to remain active (from 10 to 300 seconds - default is 10). This time starts after the ‘De-bounce time’ has elapsed.

Latch: When the ‘De-bounce time’ is ended, the alarm output relay you selected in ‘Alarm out’ will remain activated for this extra ‘latch’ period (from 1 to 300 seconds - default is 10). The latch is still valid even if you manually disable the alarm event.

PTZ activation: Here you can set PTZ movement when an alarm occurs. See below.

Alarm out: If an alarm occurred, the system will enable a peripheral alarm device connected to the selected outputs (default is 1).

Display Mon. A: Here you can set which camera views are shown on Monitor A when an alarm occurs. The system supports one- or multi-window views.

Display Mon. B: Here you can set which camera views are shown on Monitor B when an alarm occurs. The system supports one- or multi-window views.

Send email: An alert email is sent if an alarm is detected.

Show message: The system will pop up a message in the local host screen to alert you.

Buzzer: Select here to activate the buzzer when an alarm occurs.

If required, use the **<Default>** button to reset all detect fields to the factory default.

After completing setup, click **<Save>** to save your settings and go back to the previous menu.

Note

In the Detect menu, the **Copy** function is only valid for the same event type, which means you cannot copy a channel setup in video loss mode to camera masking mode.

PTZ Set

Setup the PTZ as follows for each camera associated with the input:

1. Click on the drop-down menu to set the activation operation for:
 - None (default)
 - Shot – this will swivel the channel camera to a preset PTZ position this is setup in the **Camera > Configuration > PTZ** submenu
 - Tour – this will switch the channel views in a preset sequence
 - Pattern – this will swivel the camera in a pre-assigned pattern
2. Click on the next field to enter a pre-position number from 0 (default) to 255 to send the camera to a specified pre-position.
3. Repeat these steps for each of the PTZ cameras that require a preset.

If required, access the Pan/Tilt/Zoom menu (**Main menu > Setting > Pan/Tilt/Zoom**) to setup the video channel, baud rate, dome protocol, etc.

8.4.2

Video loss

The recorder can process input alarms from the recorder alarm inputs and from IP camera alarm inputs.

See section **Alarm > Motion detect** for a description of applicable fields.

One extra field not described is:

Type: choose between **Normal open** (default) or **Normal closed** for the input alarm type.

8.4.3

Input alarm

The recorder can process input alarms from the recorder alarm inputs and from IP camera alarm inputs.

See section **Alarm > Motion detect** for a description of applicable fields.

One extra field not described is:

Type: choose between **Normal open** (default) or **Normal closed** for the input alarm type.

8.4.4

System alarm

Use tabs in this menu to setup how the system reacts to different system alarms (HDD, Network, Temperature, Other).

HDD

- **Enable:** select to enable the system event chosen in the following field.
- **Event type:** choose from
 - Disk full
 - No HDD
 - Disk error
- **Alarm out:** select the alarm activation output port(s) (maximum of 3 on DIVAR 2000/3000; 6 on DIVAR 5000).
- **Latch:** set a delay time (from 10 seconds (default) to 300 seconds) before the system automatically turns off the alarm and the activated output after the external alarm is cancelled.
- **Send email:** system will send an email to alert you when an alarm occurs.

- **Show message:** system will pop up a message on the local screen to alert you when an alarm occurs.
- **Buzzer:** the buzzer alerts you when an alarm occurs.
- **Alarm when disk is full for xx %:** (this option is only shown for the event 'Disk full'; default is 80%).

Network

- **Enable:** select to enable the system event chosen in the following field.
- **Event type:** choose from
 - Network lost (disconnected)
 - IP conflict

See above for a description of other fields.

Temperature

Enable: select to react to a temperature alarm.

See above for a description of other fields.

Other

Enable: select to react to other alarms (e.g. battery error).

See above for a description of other fields.

8.4.5

Alarm Out

Assign here the settings for each of the available alarm outputs or use the 'All' checkbox to select all outputs:

- Automatic control: Set the alarm to react to an automatic input.
- Activate manually: Turn on the alarms to react to a manual input.
- Deactivate manually: Turn off the alarms.
- Alarm status: displays the current status of the external alarm (a checked box means the alarm is activated)
- Deactivate alarms: Click this button to turn off the current alarm settings.

8.5 Schedule

Here you can plan and set up schedules for efficient use of the channels while effectively covering most recording needs. You can also assign holiday intervals.

8.5.1 Weekdays and Holidays

Weekdays

Recording is scheduled in a weekly calendar, with the possibility to change the behavior of each day for a maximum six different time periods (this is useful for weekends or nights). This calendar is then repeated for subsequent weeks.

Different recording modes can be assigned

- **Regular**
- **Motion (Motion Detection)**
- **Alarm**

If you choose combined options, the system will not separately record if an MD or an alarm occurs simultaneously

Each record mode changes the quality and frame rate settings according to their settings in the menu **Setting > Camera > Recorder**. A mode is specified in intervals of 1 hour for each day of the week.

When scheduled times are assigned, the record modes are graphically shown as color bands on the bottom of the screen over the selected 24-hour period:

- green for regular recording
- yellow for Motion
- red for alarm recording

Edit a schedule

1. Select the required channel number under **CAM** (select "all" if you want to schedule all the channels).
2. If required, choose **Pre record** to start the video recording a few seconds before the event occurred in the file (from 1 to 30 seconds depending on the bit stream).
3. There are 2 methods to schedule a day and a time:
 - use your mouse to drag different settings in the graphical interface for the various days
 - Select **<Configure>** and type in the values in the relevant fields - see following steps
4. Select the appropriate checkbox for weekday(s) Monday to Sunday, or **All** (if the same period is required for each weekday).
5. Enter the times required for different periods (maximum six) for the chosen weekday(s).
6. Assign the mode for each different time period - choose **Regular**, **MD**, **Alarm** and/or **MD & alarm**.

After completing the setup, click **<Save>** to save the settings and return to the previous menu. If holiday(s) need to be added to the schedule, choose the **Holiday** tab - see below.

Holidays

Use this tab to add holiday periods to the schedules:

1. Select the required channel number (select "all" if you want to schedule all the channels).
2. If required, choose **Pre record** to start the video recording a few seconds before the event occurred.
3. Choose the record mode for the holiday period (Regular, Motion, Alarm).
4. Click **<Add>** to open a calendar for holiday periods.
5. Click on the required holiday periods (choose other months and years if required).
6. Select each Repeat steps 5 and 6 to assign the holiday settings.

8.6 Storage

8.6.1 HDD manage

Here you can view and manage the HDD(s) installed in your DVR:

- **SATA:** shows the install Slot ID, Size and Mode (read/write) of installed hard disk(s) where the system can continuously record (overwriting the oldest unprotected video on the hard disk(s) with newer video).
 - To change the mode, or format a HDD, first select the field to the left of the slot number and choose **<Apply>** or **<Format>**(you must enter your password to confirm a format).
- **E-SATA (only available on the DIVAR 5000):** shows current selected e-Sata devices where the system will continuously record. If required, press **<Detect>** to detect new e-SATA connections.



Notice!

System reboot required

You must reboot the system to activate any modifications

Go to **Info > HDD > General** to see more information on the HDD(s).

RAID

The system can be put into RAID-1 (with 2 disks) or RAID-5 (with 4 disks). Do this as follows:

1. Select the appropriate raid option and press **<Apply>** to start building the raid system.
2. During the build of the raid, a progress bar is displayed. If a disk is faulty and has been replaced, select the appropriate Slot and press **<Rebuild>** to rebuild the raid system. Until the raid is repaired, a system alarm will be generated to indicate the RAID is no longer safe.

When a system is in raid, the **General** tab will show the complete RAID as a single disk.

8.6.2 Recording

Here you can manage the storage of recordings:

HDD full: assign here what to do when the HDD is full

- Overwrite old recordings starting with the oldest (default)
- Stop recording

Auto delete old files: assign what to do with old files on the storage device

- Overwrite old recordings starting with the oldest (default)
- Stop recording

Main stream recording: assign here how to record the main stream on each individual channel

- Schedule - record according to the scheduled times set in the tab **Schedule**
- Forced on - record continuously (in this mode, motions are not recorded or affecting video records)
- Off - do not record

Sub stream recording: assign here how to record the sub stream on each individual channel

- Schedule - record according to the scheduled times set in the tab **Schedule**
- Forced on - record continuously (in this mode, motions are not recorded or affecting video records)
- Off - do not record

**Notice!**

The recorded Sub stream is for remote playback only. Playback of the recorded Sub stream on the local unit is not possible.

9 Operation

9.1 User controls and menus

The following user controls are available:

- Mouse – (the preferred input device when setting up the system and entering field values)
- Front panel
- Remote control
- Remotely via the Web-based Configuration application
- Connected keyboard (only on DIVAR 5000) – see relevant keyboard manual

The DIVAR uses the **Main menu** and **Quick menu** to perform all operating steps and give access to several functions to help configure and use the unit.

Note: Some menu options are only accessible with an Administrator login.

9.1.1 Mouse Controls

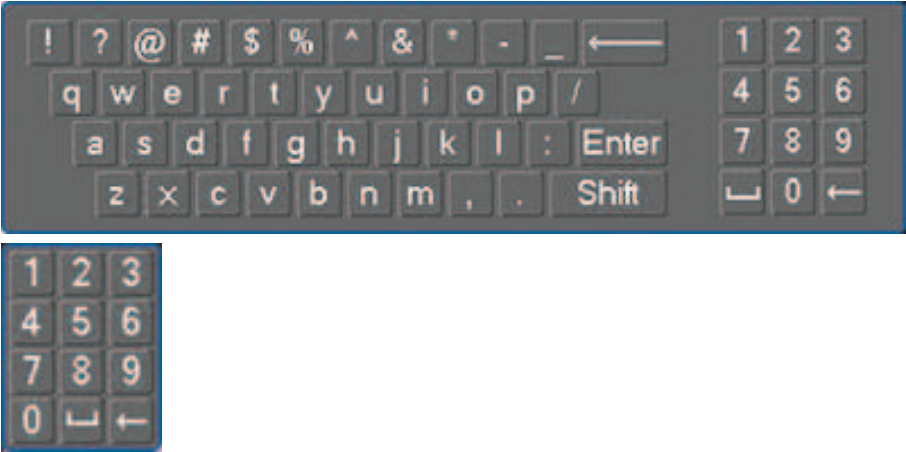
Mouse	Function
Left button	In Live mode, click once to select channel and choose other functions
	In the Quick menu , use the left mouse button to enter a menu item (left-click again to make selections in menu)
	When inputting data, one of the following input keypads appears (depending on whether you need to enter alphanumeric or only numeric characters): 
	Left click the corresponding button on the keypad to input the required characters (use Shift on alphanumeric keypad to switch between small/capitalized)
Double-click left button	Implement a special control operation, e.g. double-click an item in the file list to play the video
	In multiple window mode, double-click one channel to view in full-screen mode; double-click current video again to go back to previous multiple window mode
Drag mouse with left button pressed	Select motion detection zone in the Detect menu
	Select a privacy mask zone (in Encode > Overlay menu).

Middle scroll wheel	In numeral input box, increase or decrease numeric value
	Switch items in a check box
	Page up or page down in a list
Right button	In Live mode, the Quick menu appears:
	If you are currently in a menu, right-click to exit the current menu without saving any modifications.

9.1.2

Front panel controls

All functions controlled by the USB mouse can, alternatively, be accessed using the front panel buttons.









Figure 9.1: Front panel DIVAR 2000/3000







Figure 9.2: Front panel DIVAR 5000



Symbols on the buttons show the applicable function; see the following table:

Button	Symbol	Function
Power On/Off		Press briefly for 3 seconds to power up or power down the DIVAR. The button is lit green when power is on
Shift	Shift	When entering characters in a field, click to switch between numeral, text capitalized and text non-capitalized When selecting camera channels (on the DIVAR 2000/3000), press first the Shift button and then the required channel number – see the keys below with number functions
Up / Down		In menu mode, move up and down through menu items or values
		Increase/decrease numeral in a numeric field
		In PTZ mode, use to control the tilt functions of the selected camera
		In text mode or when choosing a camera channel, input number 3 or 9 (only on the DIVAR 2000/3000)

Left Right		In menu mode, move around through menu items or values
		In PTZ mode, use to control the pan function of the selected camera
		In playback, click to control playback bar
		In text mode or when choosing a camera channel, input number 6 or 7 (only on DIVAR 2000/3000)
ESC	ESC	Go to previous menu, or cancel current operation
		In playback, click to restore real-time monitor mode
Enter		Select a submenu or menu item, or confirm selections made in menus
		Go to default button
		Go to Quick menu
Window switch	Mult	Click to switch between one-window and multiple-window (2, 4, 9, and 16)
Assistant	Fn	In one-window monitor mode, click to display assistant function: PTZ control and image color
		In motion detection setup, use the Fn and direction keys for setup
		In text mode, click to switch between numeral, English character (small/capitalized), etc. Press for 1.5 seconds to delete the previous character before the cursor
		Realize other special functions
Slow forward		Multiple slow play speeds or normal playback In text mode or when choosing a camera channel, input number 5 (only on DIVAR 2000/3000)
Fast play		Various fast speeds and normal playback In text mode or when choosing a camera channel, input number 4 (only on DIVAR 2000/3000)
Play previous		In playback mode, playback the previous video In text mode or when choosing a camera channel, input number 7 (only on DIVAR 2000/3000)
Reverse/Pause		In normal playback or pause mode, click to reverse playback In reverse playback, click to pause playback In text mode or when choosing a camera channel, input number 1 (only on DIVAR AN 3000)
Play Next		In playback mode, playback the next video In menu setup, scroll down the dropdown list In text mode or when choosing a camera channel, input number 8 (only on DIVAR 2000/3000)

Play/Pause	 2	In normal playback, click to pause playback In pause mode, click to resume playback In text mode or when choosing a camera channel, input number 2 (only on DIVAR 2000/3000)
The DIVAR 5000 also has the following buttons		
Export		Export the currently selected files to an external device
Sequence		Activate the camera views in a pre-set sequence
Numeric keypad		Switch camera channels In text mode, enter characters in a field (use the Shift button to change the input mode)

The front panels also have the following status lights and a USB connector:

Status lights	Symbol	Function
Channel record	1-16	A channel number is lit if the channel is recording. For 32-channel units, press <Shift> and hold in for 5 seconds to show recording status of channels 17 to 32. Release <Shift> again to return recording status view of channels 1 to 16. This function only works in 'Live' mode, with no menus open.
Hard disk		Is lit if an installed hard disk has an error or is full.
Network		Is lit if a user is connected to the DVR online.
USB port		Connect USB storage device or USB mouse to this port.

9.1.3

Remote control

All functions controlled by the front panel and USB mouse can, alternatively, be accessed using the supplied remote control.

The IR remote control allows control of up to 999 units without interfering with one another. An ID number must be chosen on the remote control and in the system (see menu **Setting > General** for setting a system ID for each unit).

To set the ID on the remote control:

1. Press the **Add** button on the remote control.
2. Press a number between **0** and **998** that corresponds to the unit ID you wish to control (this unit will remain as the default until you select another unit with the **Add** button).
3. Press the **Enter** button to set the unit ID.

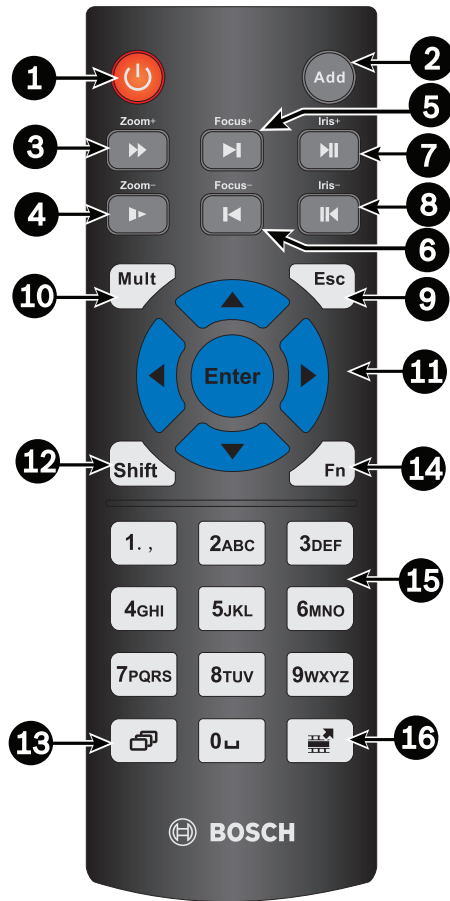



Figure 9.3: Remote control

See the following table for detailed information on each of the remote control buttons.

Button ID	Name	Function
1	Power button	Start up or shut down the device (may be password protected)
2	Address	Input a device number to be controlled
3	Forward	Multiple fast-forward speeds or normal playback
4	Slow forward	Multiple slow-play speeds or normal playback
7	Play/Pause	In pause mode, click for normal playback
		In normal playback, click to pause playback
		In real-time monitor mode, click to enter video search menu
8	Reverse/pause	In reverse playback pause mode, click for normal playback
		In reverse playback mode, click to pause playback
9	Esc (Cancel)	Go back to previous menu or cancel current operation (close upper interface or control)

10	Mult	Switch between multiple-windows and single-window
11		In menu mode, move up and down through menu items or values Increase/decrease numeral in a numeric field In PTZ mode, use to control the tilt functions of the selected camera
		In menu mode, move around through menu items or values In PTZ mode, use to control the pan function of the selected camera In playback, click to control playback bar
	Enter	Go to default Go to the selected menu
12	Shift	Switch the input of characters between numbers, text capitalized and text non-capitalized
13	Sequence	Activate the camera views in a pre-set sequence
14	Assistant (Fn) key	In 1-ch monitor mode: pop up assistant function : PTZ control and image color
		In PTZ control mode, switch the PTZ control menu
		In motion detection mode, use together with the direction keys to complete setup
15	0-9 number key	Switch camera channels (for channels 10 to 16, press 1 then second number within
		In text mode, enter characters in a field (use the Shift button to change the input mode)
16	Export	Export the currently selected files to an external device

9.1.4 Quick menu

When in live viewing mode, right-click the mouse for the **Quick menu**. Options here are:
View 1, 4, 8, 9, 16, 32 - choose here the number of view windows shown on Monitor A (one-window, four-windows, nine-windows, 16-windows or 32-windows). For each window view, select also which channels (cameras) to display

View monitor B (optional) - a popup appears where you can assign the view windows and channels for images to be shown on monitor B

Assign camera - assign the 1st or 2nd stream of a camera to the selected view window

Save View - save the current layout of view windows in a new view or overwrite an existing view

Pan/Tilt/Zoom - only possible if you have a PTZ camera attached and configured

Search/Play - search for records, and play/export them

Event search - search for events (alarms), and play/export them

Snapshot - make a snapshot of the current live camera images:

- A disclaimer screen may initially appear when you select **Snapshot** (click <Accept> to continue).
- Choose to export the snapshot to an email address, a USB memory device, and/or a DVD.

Sequence on - activate a camera tour sequence on Monitor A (to disable the sequence, access Quick Menu again and select 'Sequence off')

Alarm output - access the alarm output screen to configure the alarm output relays

Logout user - logout the current user (a popup appears to confirm logout)

Main menu - for settings and user modes



Notice!

The Pan/Tilt/Zoom setting applies for the currently selected channel. If you are in multiple-window mode, the system automatically switches to the corresponding channel.

9.1.5 Main menu

Access the Main menu as follows:

- Use the Enter key and the direction buttons on the front panel or the remote control
- Right-click the mouse for the quick menu and select '**Main menu**'

Here you can select the following sub-menus:

- **Playback** to play recordings
- **Event search** to search for events/alarms over a set period (all events can be previewed, played and exported as required)
- **Export** to export your recorded files to a memory device
- **Setting** for system configuration
- **Info** for relevant system status information
- **Shutdown** - shutdown or restart your system, plus logout

9.2 Live screen

The units have a maximum possibility for three monitor outputs (depending on available connectors on the rear of the unit):

- two for monitor A
- one for monitor B.

Refer to the descriptions below, and to menu **Setting > System > Display**, to see how to configure the monitor displays.

9.2.1

Live mode

Once the Startup Wizard is completed, your monitor will show the live viewing mode with 1 to 32 real-time images on the display (from a maximum 32 connected cameras). The system date and time is displayed in the top right corner of the screen, and the channel ID is shown in the bottom left of each channel display.

From here, use the mouse (or front panel buttons, or remote control) to control your system via on-screen icons and the **Quick menu** (accessible by right-clicking the mouse).

Make any required configuration changes via the **Main menu** (last selection on **Quick menu**).

- To change system date and time, use **Main menu > Setting > System > Date & Time**.
- To modify the channel ID, see display settings (**Main menu > Setting > Camera > Configuration**).
- To change the camera view configuration, access the **Quick menu** and select View 1, 4, 8, 9, 16 or 32.

If multiple channels are displayed, double-click on a particular channel to show this channel in full-screen (double-click on it again to return to multiple-channel view). The currently selected channel is shown with a green border.

Each channel may also display one or more of the following icons:

	Recording – shows a channel is recording
	Motion detection – a movement has been detected in the camera view





Instant playback, Zoom, Snapshot and Remote

Move the mouse to the top of a camera display to show the control bar:



Click an icon for the following functions:

Icon	Name	Function
	Instant playback	<p>Playback the previous 1-60 minutes recorded on the current channel (default is 5 minutes). Click the play bar to any playback start time (use the pause and exit functions as required). During playback:</p> <ul style="list-style-type: none"> - channel id and record status of current channel are hidden (they only reappear once you exit preview playback) - you can not switch the displayed channel or change current window-display mode <p>Set the playback time in Main menu > Setting > Playback.</p> <p>Note: The system may pop up a dialog box if there is no recorded data for the current channel, or you need to accept a disclaimer before playing.</p>

	<p>Snapshot</p>	<p>Make a snapshot of the current channel display. The system will ask to export the snapshot to an email address, a USB memory device, and/or a DVD: Note: A disclaimer screen may initially appear when you first select Snapshot (click <Accept> to continue).</p>
	<p>Zoom</p>	<p>Zoom in on a specified zone of current channel (also supported in multiple-channel view).</p> <ol style="list-style-type: none"> 1. Click the Zoom icon - it will change to . 2. Hold down the left mouse button while selecting a screen area. 3. Release the button to zoom in on the selected area. 4. Right-click the mouse to exit the zoomed area. 5. Exit the zoom function by clicking on the icon again – it will change back to .
	<p>Remote (not shown in hybrid models)</p>	<p>Directly open the camera configuration screen to assign a (new) IP camera to this channel.</p>

9.2.2



Pan/Tilt/Zoom

This function is only possible if PTZ cameras are connected to the DVR (usually via the RS485 port).

To swivel the camera view, click on any of the eight direction arrows on the left of the screen

Use this menu to also setup the following PTZ properties:

- Speed: adjust the speed of the camera movements (value ranges from 1 to 8).
- Zoom
- Focus (only for analog and Bosch IP cameras)
- Iris (only for analog and Bosch IP cameras)

Click on icons  and  to increase or reduce the zoom, focus and iris

The other buttons on the bottom of the screen are used for analog cameras only, to assign and activate a set of movements for the camera as follows:

1. Enter a number (from 1 to 999) in the right field (this will be the ID for the preset PTZ movements for the camera).
2. Use the eight direction arrows to swivel the camera to a desired position.
3. Click **<Set>** to assign the final position to the ID.
4. You will be asked to save the preset (use the focus  button to save). This preset can be eventually added to the PTZ activation sequence if an alarm is detected - see **Settings > Alarm**.
5. If required press **<Shot>** to move the camera immediately to a preset ID position.

The Aux buttons are used when activating an ID for special processes stored in the camera:

- **Aux On:** refer to your camera manual for the Aux definition.
- **Aux Off:** switch off the special Aux definition

NOTE: For IP Cameras, the Iris, Focus and AUX operations only work for Bosch cameras.

9.2.3

Sequence

Setup the camera sequence and interval times as follows.

Activate sequence on monitor A (or B)

1. To view a sequence of live camera pictures from several cameras:
 - Right-click the mouse to access the Quick menu
 - Choose **Sequence on**
2. Check that a sequence of camera pictures appears,
3. To stop sequencing, right-click the mouse to access the Quick menu, and choose **Sequence off**

NOTE: The sequence can be paused by clicking inside the sequence icon. This allows the user to switch between cameo's and view windows and control the PTZ of cameras. To resume the sequence mode, simply select the icon again. This applies to sequence modes started with the normal sequence on/off option as well as for sequence mode started by alarm event display.

9.2.4**Monitor A**

Monitor A shows live pictures of connected cameras in full-screen or multiscreen, plus status messages and alarm events (e.g. motion and video loss warnings). When multiple events occur, camera pictures can also be sequenced on monitor A to follow the events. The search/play function and all user menus are also activated on this monitor.

9.2.5**Monitor B (only for DIVAR 5000 models)**

Monitor B displays live pictures in full-screen or multiscreen (up to 16 channel can be shown at one time, with a choice of which channels to show e.g. channels 1 to 16, or channels 17 to 32).

If an alarm/detect event is signaled, the camera picture with the event can be displayed on monitor B. When multiple events occur, camera pictures can also be sequenced on monitor B to follow the events.

9.3 Playback

Click **Search/Play** in the Quick menu (or **Playback** in the Main Menu) for the following screen.
 Note: A disclaimer screen may initially appear (click **<Accept>** to continue).

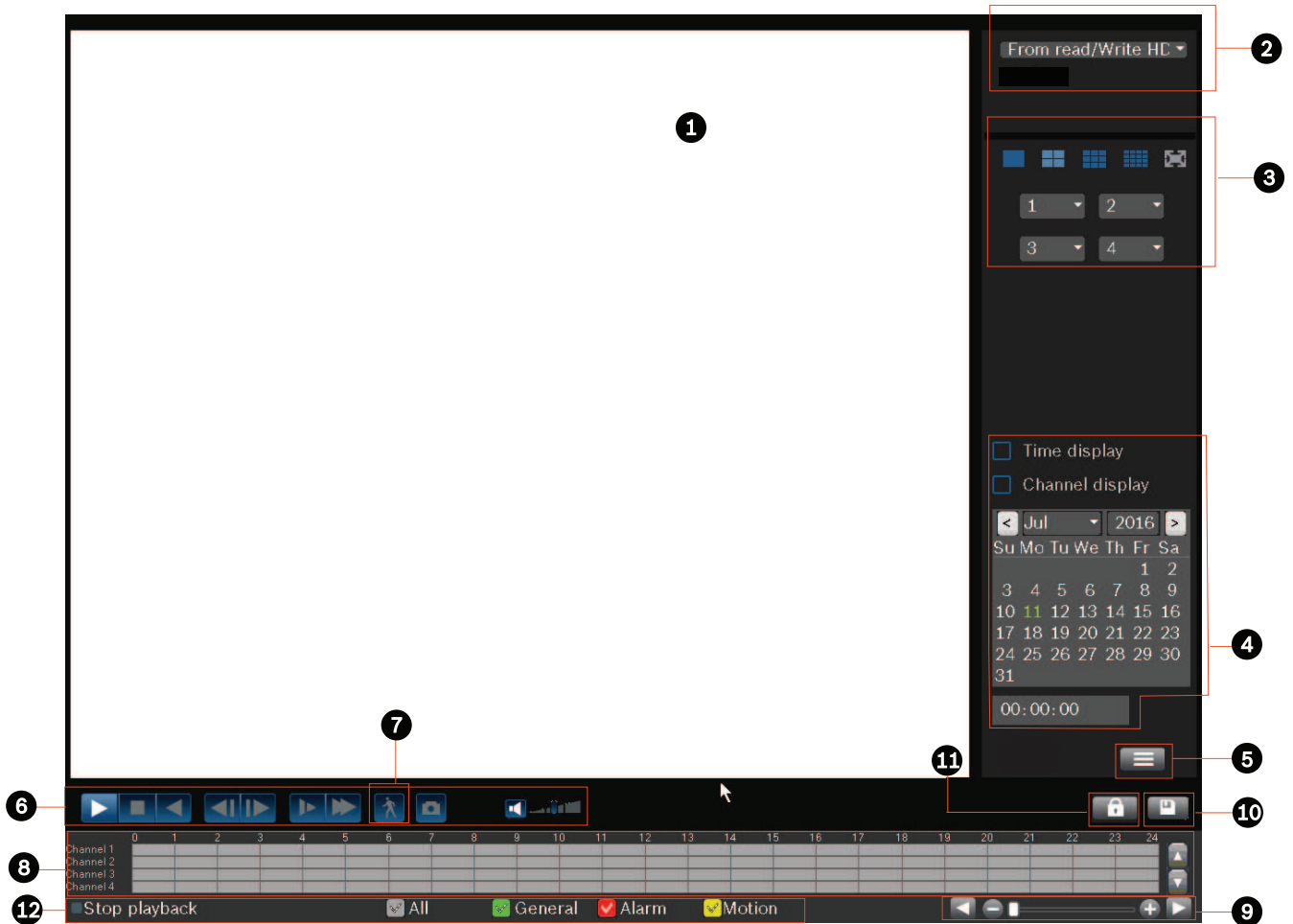

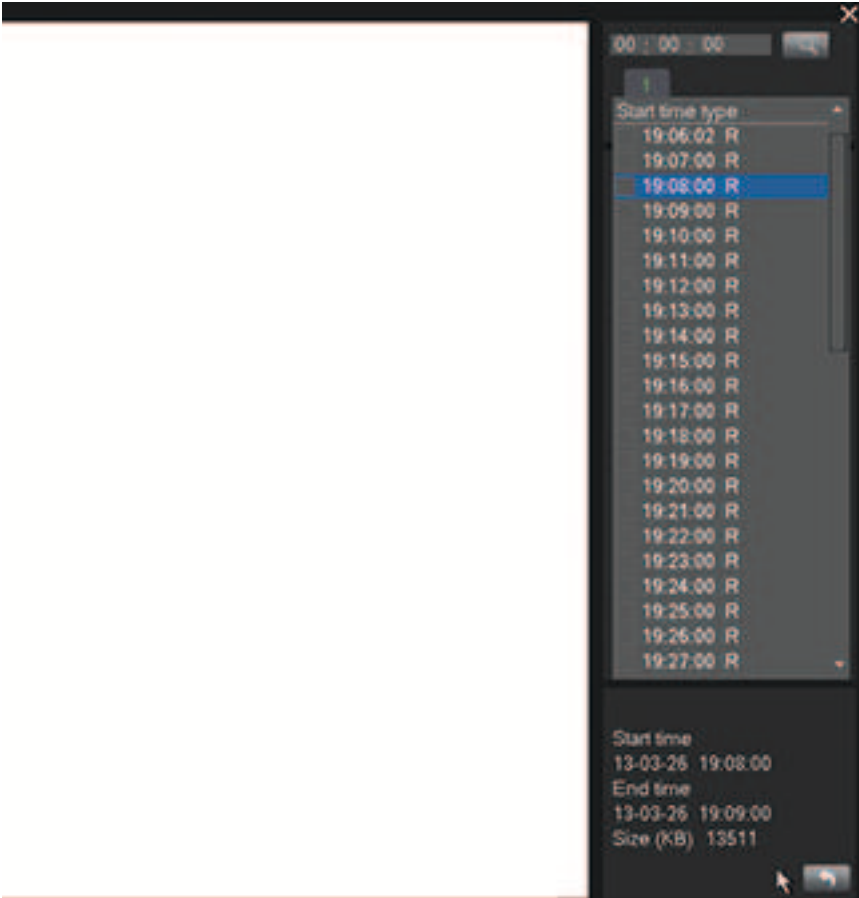
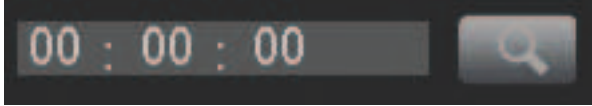

















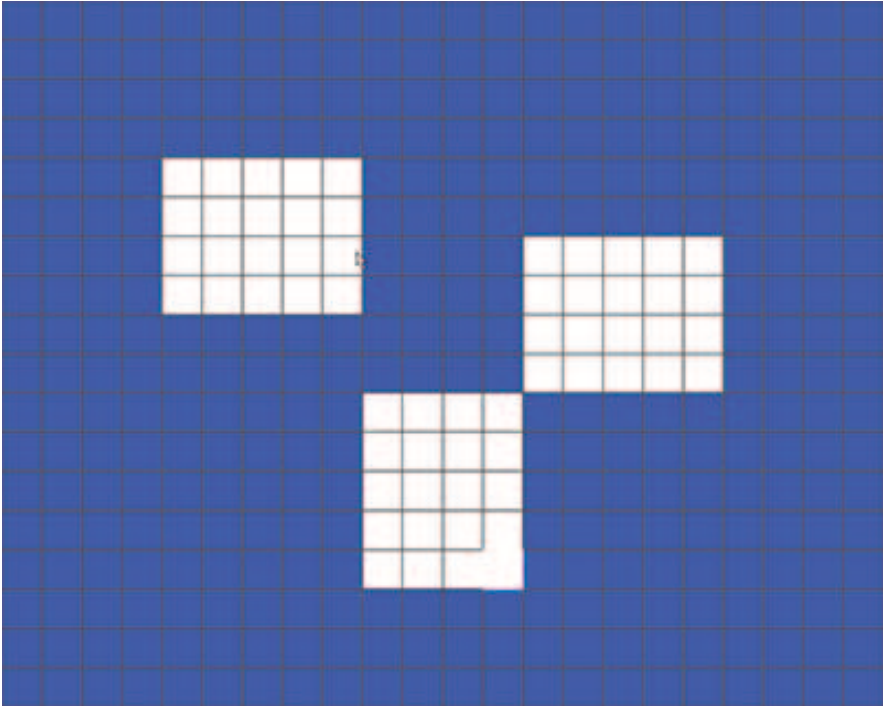



Figure 9.4: Search/Play screen

See the following table for an overview of the features on this screen.

ID	Name	Function
1	Display window	Display of the currently chosen picture or file (supports 1/4/9/16-window playback.)
2	Search type	Here you can select to search for a recorded file. Select to play from the internal HDD or an optional connected external memory device.
3	Playback mode and channel selection pane	Choose between 1/4/9/16 window or full screen (toggle the buttons during playback to switch between views): <ul style="list-style-type: none"> - 1-window – select which channel to display from the drop-down menu (select ‘.’ for no channel) - 4-window (select which 4 channels to display) - 9-window (select channels 1 to 9) - 16-window (switch between 1-16 and 17-32 channels – only available for DIVAR AN 5000)

		<ul style="list-style-type: none"> - Full-screen (click right mouse button to exit full screen)
4	Calendar and time	<p>Select a date to overview the recordings available for that day (dates highlighted in blue have recordings available for that day). The time bar on the bottom of the screen will show a 24-hour trace of the recordings available for the chosen date.</p> <p>If required, play a recording for a particular date as follows:</p> <ul style="list-style-type: none"> - Assign a start time (hour, minute, second) in the time field (below the calendar) - Press the play button  - Click on a colored zone on the time bar (at the bottom of the screen) to start playing at that selected time - Note: Select 'Time display' and/or 'Channel display' to show this information as an overlay in the chosen recording.
5	File list	<p>This option is only displayed if it is enabled in the 'Settings > Playback' menu.</p> <p>Double click to view a list of recorded files for the selected day.</p>  <p>The list displays the first channel of the recorded file (click the numbers above to select another channel). A maximum 128 files are shown at one time. The character shown beside each file has the following meaning:</p> <ul style="list-style-type: none"> R – regular recording A – external Alarm recording M – motion detect recording

		<p>The time span of 'R' recorded files in a file list is set by default with a duration of 1 hour (i.e. from 8:00 to 9:00, 9:00 to 10:00, etc.). 'M' and 'A' files span the time that the motion/alarm occurred.</p> <p>Click once on a file to view the file details under the list, or double click a file to playback the file on the screen.</p> <p>For a precise search for a time period, stop the current file being played and enter a period in the time panel (shown above the list):</p>  <p>When ready, return to the original calendar and channel setup interface by clicking </p>
6		<p>Play or Pause (the 'pause' button is displayed if the DVR is already playing and you wish to pause the play)</p>
	<p>Stop playback</p>	
	<p>Backward play</p> <p>In normal play mode, left click this button to play the file backwards. Click it again to pause current play.</p> <p>In backward play mode, click  to restore normal play.</p>	
	<p>In playback mode, click to play the next or the previous section (click continuously to watch consecutive files from the same channel).</p> <p>In normal play mode, press pause then click  and  to begin frame-by-frame playback.</p> <p>In frame-by-frame playback mode, click  to restore normal playback.</p>	
	<p>Slow play</p> <p>In playback mode, click for various slow play modes such as slow play 1, slow play 2, etc.</p>	
	<p>Fast forward</p> <p>In playback mode, click to realize various fast play modes such as fast play 1, fast play 2, etc.</p>	
	<p>Smart search (only available for analog cameras connected to a hybrid recorder) – see description below</p>	
	<p>Turn the audio on/off and adjust the volume during video playback</p>	
	<p>Click to export snapshot(s) to a USB memory device, a DVD, and/or an email address.</p> <ul style="list-style-type: none"> - A disclaimer screen may initially appear when you first select Snapshot (click <Accept> to continue). <p>See heading 'Export snapshot' for more information.</p>	
<p>Digital zoom</p>	<p>When the system is in playback mode:</p> <ol style="list-style-type: none"> 1. Left-click the mouse in the screen and hold down the mouse button. 	

		<ol style="list-style-type: none"> 2. Drag to select a section then release the mouse button. 3. Left-click in the selection for digital zoom of the selection. 4. Right-click to exit zoom.
7	Smart search	<p>This function is only available for analog cameras connected to a hybrid recorder, and is only active when the system is playing a recording in 1-window mode.</p>  <p>Click  to activate smart search. See following figure.</p>  <p>Use your mouse to drag and select zone(s) in the window to detect motion.</p>  <p>Click  again to begin smart search. The system searches for motion in the chosen area(s).</p>  <p>When ready, click  again to stop smart search playback.</p> <p>Extra notes on smart search:</p> <ul style="list-style-type: none"> - As default, the system will view the whole play zone as a motion detect region. - If you choose to play another file in the file list, the system will switch to motion detect play of the other file. - During motion detect play, you cannot implement operations such as changing the time bar, play backward, or play frame-by-frame. - System supports 396 (22x18 PAL) and 330 (22x15 NTSC) zones.
8	Time bar	<p>Displays a maximum 32 channel time bars for the current search date (use the scroll bars on the right to scroll up and down through the available channels). The color of each channel bar changes depending on if a recording is present for the chosen date:</p>

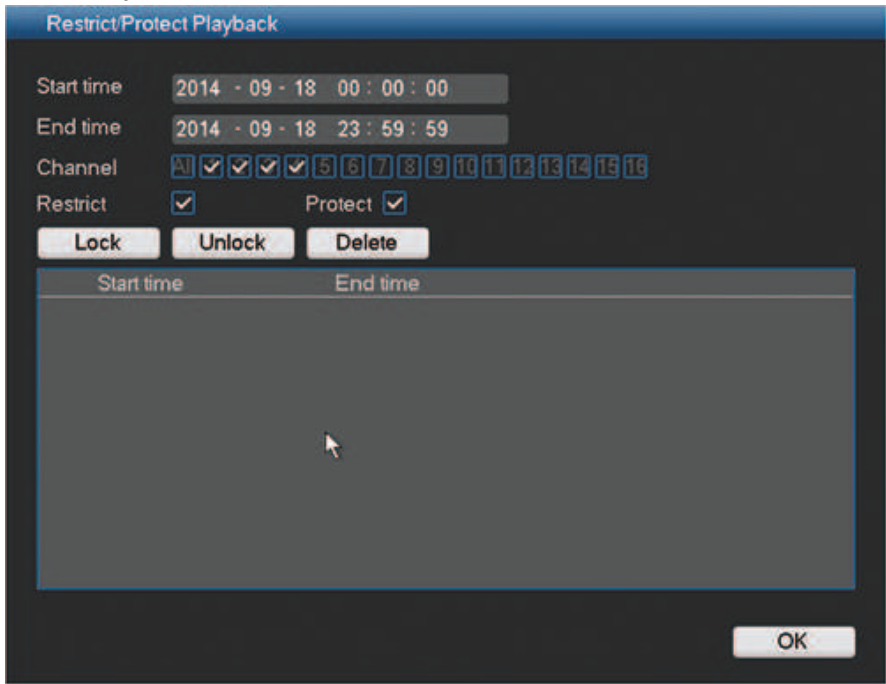
		<ul style="list-style-type: none"> - Green for a regular record file - Red for an external alarm record file - Yellow for a motion detect record file <p>Click on a point in a colored zone in the time bar to begin playback at that point.</p> <p>Alternatively, hold down the left mouse button and select a region of the time bar (the region will be highlighted); right-click on the selected region to display a menu for the following functions (Export; Restrict/Protect playback; Clear region) – see separate descriptions here for Export and Restrict/Protect.</p> <p>During playback, click on the top of the time bar and hold down the left mouse button to scroll the time bar left or right (not applicable for 24-hour).</p> <p>Alternatively, use the time bar unit to zoom in, or scroll (see the following description).</p>
9	Time bar unit	Use the buttons here to zoom in on the time bar or scroll left or right (this helps to precisely locate a time in the time bar when playing a recording). Alternatively, use the mouse middle scroll wheel to zoom in or out.
10	Export 	Use to export recordings onto a memory device (recordable DVD or USB storage device). See heading ' Export ' for more information.
11	Restrict/Protect	<p>Use this function to restrict playback of a recording and/or to protect that recording from being deleted. The restrict/protect permission can be individually set for each user account.</p>  <p>Restrict/Protect recording(s) as follows:</p> <ul style="list-style-type: none"> - Assign a start and end time - Choose channel(s) - Choose checkbox for Restrict and/or Protect - Select <Lock> to lock the segment (the recording appears in a list with start and end time). Repeat these steps for new recordings as needed.

		<ul style="list-style-type: none"> - If required, unlock a recording by selecting its checkbox and select <Unlock>. Delete a recording permanently with <Delete> - Select <OK> to save the settings (depending on user access, all restricted/protected recordings will show a blank screen with a lock logo when playing) <p>Important: When entering a start and end time for Restrict/Protect playback, be aware that the selected time may include a portion of a recorded file. In this case the complete file will be Restricted/Protected. For example, if you set a start time of 9:30 and an end time of 10:30 then both the recorded files 9:00 to 10:00 and 10:00 to 11:00 will be selected for restrict/protect because they both include portions of the selected time span. The same principle applies if you Delete a time period from 9:30 to 10:30 then both the files 9:00 to 10:00 and 10:00 to 11:00 will be deleted.</p>
12	Record type	<p>Only displayed if 'Show timeline selection' is selected in Settings > System > Playback menu (selected by default)..</p> <p>This status line shows the current play mode (or Stop).</p> <p>The checked boxes show the recording type (All, General, Motion, Alarm).</p>

9.3.1

Export

Access the Export menu from the main menu or Search/Play screen (or by pressing the Export key on the Front Panel or on the remote control). Use this menu to write segments of recorded video to a USB storage device or recordable DVD.

1. Choose from the **Selected Device** pull-down list to export recording(s) to either a USB memory stick or CD/DVD. If required, <**Refresh**> the device selection, or <**Format**> the selected memory device.
2. Choose the save location on the memory device (<**Browse**> if necessary).
3. Select the **Type** of file to export (All, Alarm, MD, Normal).
4. Select the File format (DAV or ASF).
5. Enter a **Start time** and **End time** for the video segments (files) to archive.
6. Select the **Channel** to archive (**All** for all channels).
7. Click <**Add**> to add the file to the export list.
8. If required, repeat steps 3 to 7 for more recordings. (Remove a selected recording by selecting its check box and pressing <**Remove**>.)

The total size of the selected recordings (and available space on the memory device) are shown.

9. Click <**Start**> to export the selected recording(s).

If the total size of the selected recordings is more than the free space on the memory device, then only the first recordings that fit are exported.

9.3.2

Export snapshot

Select the checkboxes to export snapshots to an email address, USB memory stick and/or DVD.

If required, enter an email address or choose a specific DVD or USB stick (use <**Configure**> to define a location on the USB).

Use <**Refresh**> to refresh the selection if you insert a new USB stick or DVD.



Notice!

Exporting snapshots to a DVD will first format the DVD (deleting all files currently on the DVD).

9.4

Info

Refer to the following sections for a description of these **System information** menus.

9.4.1

System Alarm

View here the alarm status of your system:

- System alarms (No disk, Disk error, No space on disk, Network lost, IP conflict, Temperature too high, Other)
- Event alarms (Motion detection, Video loss, Camera input, NVR input). Use the scroll arrows to view all camera events.

9.4.2

System Health

View here the health status of your system:

- Temperature
- CPU load
- Memory usage

- Fan speed (only for DIVAR 3000 models) - values shown are Current, Average, Highest, Lowest)

9.4.3 System Version

View here the status of your installed system:

- hardware features (device, channels, alarms in/out)
- software features
 - system version of your currently installed firmware
 - build date of the firmware
 - web id
 - serial number



Notice!

Bosch strongly recommends upgrading to the latest firmware for the best possible functionality, compatibility, performance and security.

Check <http://downloadstore.boschsecurity.com/> regularly to see if there is a new firmware version available.

9.4.4 Network Online users

Manage here the online users:

- Disconnect a user by selecting the user and press **<Disconnect>**.
- Block a user for a max disconnection time:
 - Select the user
 - Click Block time (default is 60 seconds) and select **<Block >**

The system displays a list of the blocked users, and refreshes every five seconds to detect any newly added or deleted users. To unblock a user, select the user and choose **<Unblock>**.

9.4.5 PoE usage

This info page shows a list of all cameras connected to the PoE slots, and the total amount of power they are using. Use the **Block** checkbox for a camera to prevent the camera drawing a PoE supply from that slot.

9.4.6 Network Load

See here a real time graphical display of the current load on the network for send and receive traffic. There are two network connections and the load can be seen for each network by selecting the relevant network interface.

9.4.7 Network Test

Choose here to do a **network test** as follows:

1. Enter a **Destination IP** address.
2. Click **<Test>**.
3. Check the test result in the **Test result** field.

Or choose to do a Network sniffer packet export as follows:

1. Enter a Device name (click **<Refresh>** if the device is not shown).
2. Enter an Address (click **<Browse>** to search for the correct path).
3. Select LAN.
4. When the correct sniffer packet is shown, click  to start the export.

9.4.8

HDD General

This screen provides information on the current status of each HDD. After a system start, the system will first check for any HDD error.

Earliest recording: shows the date and time of the oldest recording still available on HDD.

Latest recording: shows the date and time of the latest recording on HDD.

Recording status: shows if HDD can record or not.

Raid status: shows if HDD is used in a Raid array. Using RAID severely reduces system performance (to maintain fluent playback, it is recommended to limit the number of playback channels (e.g. 1x or 4x playback)).

Total protected size: shows the total size of all protected recordings stored on the HDD (you can protect a recording using the Protect Playback function available on the Search/Play screen).

The bottom half of the screen lists each HDD type, total size, and the free space remaining on the disk. Use the **Health** menu for more (Smart) information.

9.4.9

HDD Health

Scan

Start a scan here to view the current status of all sectors on the HDD(s) installed in your unit. A graphical representation of the HDD segments is shown, plus a readout of the health status of each HDD.

Start the scan as follows:

1. Choose Quick or Full detect.
2. Choose the HDD to be scanned.
3. Press <Start>.

Report

After a scan is run on your HDD, use the Report tab to display a quick overview of the result. Any detected errors will be shown in the **Error** column (**O** means current HDD is normal; **X** means there is a disk error; **-** means there is no HDD; **?** means disk is damaged).



Notice!

If an error (X) is shown

Check the hard disk time and system time are the same (if necessary, modify system time in **Setting > General**, and reboot the system). If the error persists, check the **S.M.A.R.T.** information (see below) and, if necessary, format the HDD and reboot the system.

If more detailed information is needed, select the 'report icon' under the View column (here you can also select the **S.M.A.R.T.** tab - see below).

To make a backup of the report:

1. Insert a USB stick into an empty slot on the unit.
2. Choose <Backup> to export the report to the USB stick.

S.M.A.R.T.

Choose here to display all of the Self-Monitoring, Analysis and Reporting Technology information that is automatically collected by the monitoring system included in hard disk drives (HDDs) and solid-state drives (SSDs). This system reports on various indicators of drive reliability, with the intent of enabling the anticipation of hardware failures.

9.4.10

Log

View here (and export) the log files containing the following system events:

- All
- System
- Config
- Storage
- Event
- record
- Account
- Clear
- Playback
- Connection

The system can display a maximum 100 logs per page and a maximum 115 pages of log files (displayed in order of newest to oldest). Use the scroll bar or **Page up/down** or **Previous/Next page** to scroll through the events if there are more than ten events.

How to use log display

1. Select which system events to show from the drop-down menu in the **Type** field (choose **All** to display all events).
2. Enter a **Start time** and **End time** in the relevant field
3. Click **<Search>** to view the log for the event type.
4. Use **<Play>** and **<Preview>** icons to view events.
5. If required, double-click on a log entry (or select the entry and click **<Details>**) to view more information on the event.
6. To save the log file to a USB stick, click **<Backup>** and enter the required fields in the **Log backup** dialog box.
7. To delete all the log files, click **<Clear>** and confirm the delete action.

9.5

Export

Assign here a schedule for an automatic export (backup) of a recording to an FTP (File transfer Protocol), SMB (Server Message Block) server, or to an eSata disk (only available for the DIVAR 5000)

- **Selected device:** choose which device to save the backup
- **Path:** choose where to save the backup
- **Type:** Select the type of video for back-up (choose between alarm recording, motion recording, alarm and motion recording, normal recording, or all)
- **File format:** DAV (default) or ASF
- **Start time:** Assign the date and start time of the backup (because a backup can drain system performance, always schedule a start time during a quiet period where features such as local playback/export are not required)
- **End time:** Assign the end date and time of the backup
- **Channel:** Assign the channel(s) to be backed up (default is All)

Press **<Add>** to add this export to the schedule list below; add more scheduled backups as required (to remove a scheduled backup, select it on the list and press **<Remove>**).

Do not forget to press **<Start>** to start the backup.

The bottom of the screen shows the progress of the backup.

9.6 Event search

Click **Event search** in the Quick menu (or **Event search** in the Main Menu) to activate the screen for searching for events.

Options in this screen are:

- **Type:** Choose from All (default), Motion or Alarm
- **Channel:** Choose All or specific channels
- **Start time:** Choose start date and time for search
- **End time:** Choose end date and time for search

Press **<Search>** to start the event search. If required, use **<Go to>** to access a particular page in the list of events. Double-click an event to display more information; press the green arrow to playback the event.

To export event file(s), use **<Browse>** to assign an export device, select the required files, then press **<Export>** (the progress of the export is shown on the status bar).

10 Archive Player operation

10.1 Getting started

The Archive Player is used to view archived recordings on a PC (each recording is a video file that has been exported from the DVR or Web Client). If required, use the Player to also check the authenticity of an archived recording before viewing.

To easily identify an archived file, check the default export name for the recording time and date.

10.1.1 System requirements

Operating platform: A PC running Windows 8 or Windows 10.

For the Archive Player, the **recommended** PC requirements are:

- Processor: Intel Core Duo, 2.0 GHz or comparable
- RAM memory: minimum 512 MB
- Graphics card: NVIDIA GeForce 8600 or higher

10.1.2 Installation

The Archive Player normally does not require installation to function. When a video is archived, the Archive Player application file (play.exe) is automatically copied to the same directory as the archived file (except when using the Web Client – see Notice below). When copying the archive file to other media afterwards, make sure to also copy the play.exe file.

NOTICE! The Archive Player will not be downloaded from the DVR when archiving is performed via Web Client. Use the Archive Player available on the Bosch website, the product CD, or download it by performing a local archive. When copying the archive file to other media afterwards, make sure to also copy the Archive playernode:106123408751015 file.

10.1.3 Starting the Player



The Player application (play.exe) is normally loaded into the same directory as the archived files and can be simply started by double-clicking on the 'play.exe' file to start the program. Another way to start the player interface (if you have installed it on your PC) is to double-click





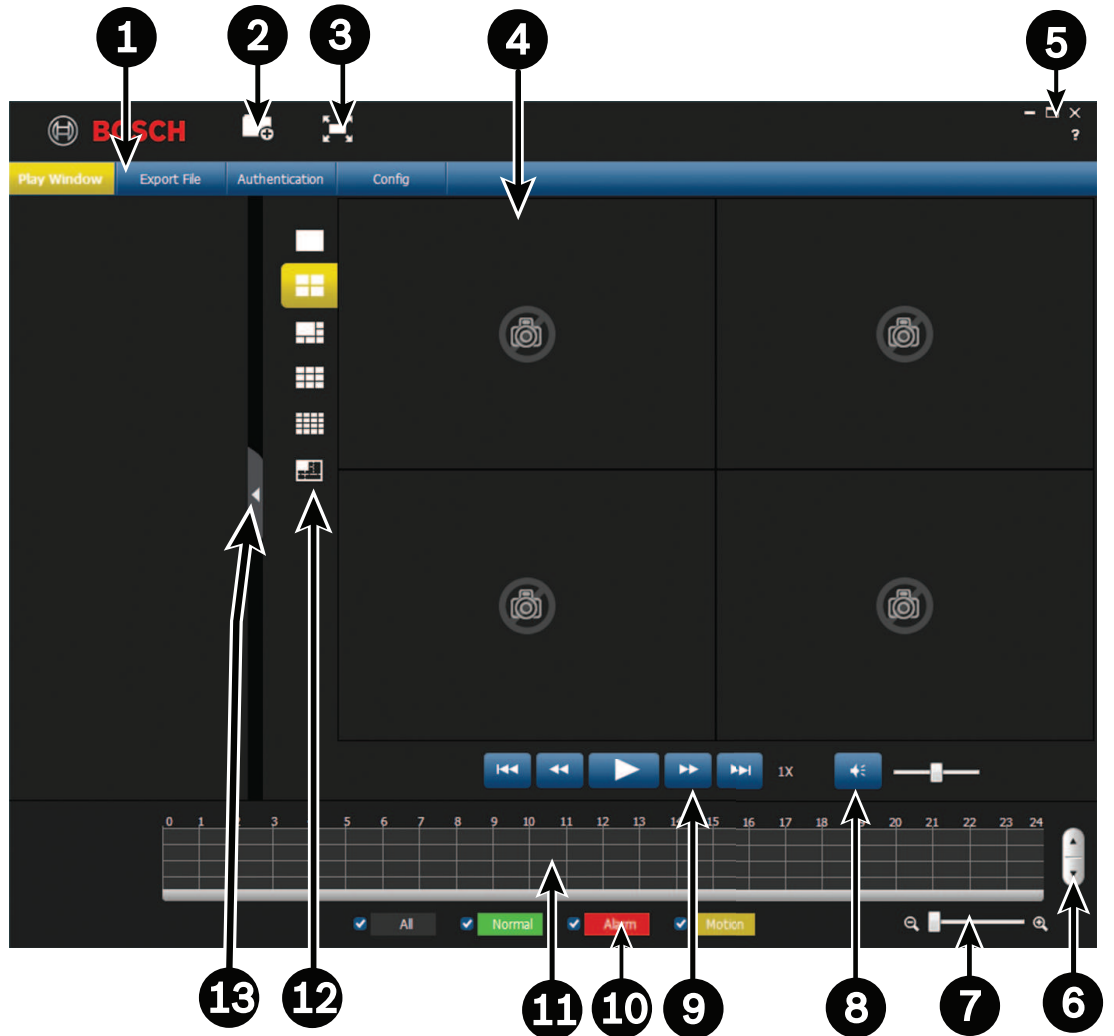







the icon in the installation path or on your desktop (if it is stored there).

Once started, the player interface screen appears; see the following figure and table for an overview of the screen and its functions:



Id	Name	Function
1	Menu bar	Here you have the following options: Play Window (default window) activates a window where you can play pre-recorded files. Export File activates a window where you can choose files to export to a pre-defined directory – see <i>Export file, page 83</i> Authentication activates a window where you can check the validity of a recording – see <i>Authentication (checking watermark), page 83</i> Config is used to setup how the player saves and formats snapshots, and the language for the user interface – see <i>Configuration, page 84</i>
2		Activates a directory overview where you can browse and choose a file to play. Double-click on a specific file to start playing.
3		Click to show player in full screen (press Esc to return to standard screen)

4	Play screen	Here you can have a maximum 16 player screens to simultaneously play a maximum 16 channels (cameras).
5		Click  to minimize player screen Click  to maximize player screen Click  to close and exit the player interface Click  to show player software version
6	Scroll channels	Scroll up and down through the different channels of the currently chosen recording.
7	Time scale	Move this scale left or right to increase or decrease the time scale on the 'Time bar' (see below)
8	Audio control	Click here to mute or activate audio (if present in recording). Move the scale bar to increase or decrease volume.
9		Play or Pause the recording (the 'pause' button is displayed if the recording is already playing and you wish to pause the play). Click a valid period in the time bar and then 'play' to start the file at that point.
		Begin play at start of recording.
		Reverse play; possible speeds are 1/2x, 1/4x, 1/8x, 1/16x, 1/32x, 1/64x
		Fast play; Possible speeds are 2x, 4x, 6x, 8x, 16x, 32x, 64x
		Go to end of recording.
10	Record type	A checked box shows the settings that were applied for the recorded file (Motion, Alarm, Normal, All).
11	Time bar	Displays the time span of the currently selected file (the colored segment). The colors are: <ul style="list-style-type: none"> - Green for a regular record file - Red if an external alarm is active - Yellow if motion detection is active A max. 16 channels (bars) are shown for each file. Click on a point in a colored zone in the time bar to begin playback at that point.
12	Screen views	Select here the number of screens (channels) that are shown (double click on a screen to show it in full screen). See 'Player control' below for a description of additional player buttons in the top of each screen
13	Tab	Click here to hide or show an extra tab showing the current file (and channels) selected

Open an archive file

After starting the player, check the relevant directory to locate your archive files (identified by file extensions .mpg, .mp4, .dav, .264, .dev, .asf).

These files can be opened and played in 2 ways:

- Using the **Open** button on the player - you will be asked to browse and select the file(s) to be played on the Player
- Use the mouse to drag an archived file onto the player (you can also drag a batch of files to store them in the player memory; the last file that is dragged onto the player is automatically started in play mode)

Player control

As the record file is playing use the player interface buttons to further control the play status of the archived files. Another control possibility is to scroll your mouse over an active channel screen to activate four separate buttons in the top of the screen – see following figure.



These buttons have the following functions:

	Show file resolution and frame rate
	Zoom in on a segment of the screen (press the button and then select the desired region by drawing a rectangle with your mouse on the screen; if required, press the button again and then scroll the zoomed image with your mouse; when finished, right-click the mouse to exit the zoomed area)
	When playing the video file, click to save current video frame as an image file to a specified directory (assigned in Config > Snap Path)
	Close the file that is currently playing

See also

- *Authentication (checking watermark), page 83*
- *Configuration, page 84*

10.2 Authentication (checking watermark)

Use **<Authentication>** to check the authenticity of individual frames:

1. Click the Open file icon and browse through the relevant directories to choose a record (file) to check.
2. Select the check box beside the file (if not already selected).
3. Click **<Start Check>** to check if the record has been modified or not.
 - The file is displayed in the right column
 - A progress percentage is displayed during the check
 - If required, press **<Stop Check>** to halt the check
4. Upon completion:
 - If the record is original, the word **Original** is displayed in the **Results** column
 - If the record is false, a warning message is displayed

10.3 Export file

Export a file as follows:

1. Choose and open a file to be exported.

2. If required, preview the file on the left screen by selecting the check box for the chosen file (if the file has multiple channels, select the check box for the required channel). Use the play, pause, and fast forward/reverse buttons as required.
3. You can also overview the recording contents using the grid in the bottom of the screen.
4. When you have decided on the recording segment that you wish to export, fill in the setup fields (Export format, Start date, End date, Start time, End time, Interval) by manually entering the field values. Or use the grid in the bottom of the screen to select start and end times.
5. Press <Start Export>.
6. In the 'Save as' dialog box, choose a directory location and a file name for the export, and press <Save>. A progress percentage is displayed during the export
If required, press <Stop Export> to halt the export
7. When prompted, export the end of the file by pressing <OK>.

10.4 Configuration

Here you can set:

- Snap shot location - assign the path and directory to save a snapshot image (if necessary, click on <Browse> and select a new path)
- Snap format - select here the format (JPG or BMP) for the saved snapshot files
- Language - choose here the language for the player user interface
- Channel Display - select the checkbox to show the recorded channel information on the video
- Time Display - select the checkbox to show the recorded time information on the video

11 Web Client Software

The Web Client software (loaded on a PC) gives full remote control of the DIVAR over the web. Up to four remote users can access and control the unit. Remote live viewing, search, playback, and system configuration are provided. Remote control functions include pan/tilt/zoom control of cameras, and video archiving. An on-line status overview of the connected unit is also provided.

To access a unit, a user must log on using the same User ID and Password used for local access. The Web Client will follow the permissions of the user account, restricting the functions available to each remote user; for example, the ability to archive video. See Operating instructions for more details on User Levels.

The **recommended** PC requirements for running Web Client are:

- Operating platform: A PC running Windows XP, Windows Vista, or Windows 7.
- Processor: Intel Core Duo, 2.0 GHz or comparable
- RAM memory: 2048 MB
- Free hard disk space: 10 MB
- Graphics card: NVIDIA GeForce 8600 or higher
- Network interface: 10/100-BaseT
- Web Browser: The current product series supports Internet Explorer.

11.1 Getting started

To use the Web Client, first connect your PC and the DIVAR via a TCP/IP network connection and load a new Web Client version as follows:

1. In the DIVAR, go to the network setup (stored in **Main menu > Setting > Network**) and check that the network settings are correct. You can also see here the IP address for the DIVAR. Make a note of the IP address for the next step.
2. On your PC start the Windows Command prompt: click **Start** > type "cmd" in the search field. Type "ping ***.***.***.***" (***= IP address) to check the connection. The return TTL value should be less than 255.
3. Open an internet browser on your PC and input the IP address for the DIVAR in the address column. For example, if the address is 10.10.3.16, then input http:// 10.10.3.16 in the IE address column. See following example.



4. The browser will ask to download and run the latest Web Client webplugin.exe (or overwrite the previous version). Always check first with your system administrator that you have sufficient rights to install the web client software on your PC (the web client executables will be loaded into the directory Program Files (x86) \ webrec).
5. Follow the dialog boxes to correctly install the Web Client. Once installed, the screen will refresh and show the login screen.

Note: The Web Client does not install 'webrec' on a PC again unless a new version is released with new firmware.



Caution!

The remote system access feature, designed to allow users to view their video via a PC or phone, may compromise their security devices and expose them to malicious use.

To avoid putting your devices and personal information at risk, always consult your network specialist for advice on network security infrastructure (i.e. MAC filtering, Access Control List). Bosch accepts no responsibility for possible damage caused by unauthorized access

11.2

How to log on

1. Open your web browser and enter the IP address for the DIVAR in the address column. For example, if your DVR IP is 10.10.3.16, then enter `http:// 10.10.3.16`
2. If Web Client is already installed, the following Login screen is shown (if Web Client is not installed, check with your administrator for how to do this):

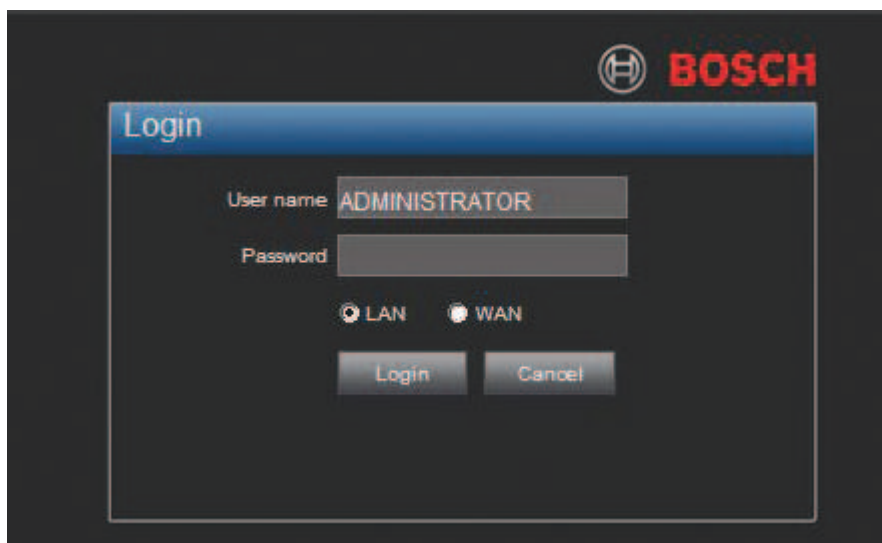

3. Input your user name and password.
4. Select the login mode: LAN or WAN (LAN is for smaller networks; WAN is best for larger networks and the internet – the differences are described in the following pages).
5. Click <Login> to access the Web Client 'Live' window – see below.

Note 1: A disclaimer screen may initially appear (click <Accept> to continue).

Note 2: For security reasons, your password must be defined after you first login.

Note 3: If the maximum number of users for the Web Client is exceeded, a message is displayed.

11.3

Web client live window

11.3.1

Live

Here you can see the live images from your cameras.

- On the left you can select the cameras you want to view. Select <Main stream> for a high resolution view with high bitrate. Select <2nd stream> for a lower resolution view with lower bitrate. Select <Open all> to open all camera streams at the same time. Please note that this can drain system performance and result in a lower update rate.
- On the bottom you can choose the presentation of the camera streams on your screen.
- On the right are controls to pan, tilt, zoom and focus your cameras and to adjust brightness, contrast, saturation and hue. With <set> you can make preset positions.
- In the right corner of each image are controls for Zoom, Record, Snapshot and Audio.

For more information see *Live mode*, page 66 and *Pan/Tilt/Zoom*, page 67 in the Operation chapter.

11.3.2 Playback mode

Click the Playback button to search and playback your recordings. Here you can:

- select different display modes (1 or 4 cameo displays, full screen)
- assign cameras to cameos
- press the user buttons to Play, Stop, Pause (with step-by-step forward and reverse play), Reverse play, and adjust the play speed
- turn audio off or on (and adjust volume)
- jump to a specific date and time to view playback video
- view a graphical timeline of the day for recording, input, or motion events
- see unit status and alarm conditions

See *Playback*, page 69 in the Operation chapter for a detailed description.

If your web connection has low bandwidth:

- Only I-Frames are initially streamed to save bandwidth (in full screen, an I-Frame will be streamed every second).
- Playback starts at half-speed by default (the speed can be changed to single speed by pressing FWD).
- Exporting files may be slow.

11.3.3 Event search

Click **Event search** to search and playback a selected event.

Choose here:

- **Type:** Choose from All (default), Motion or Alarm
- **Channel:** Choose All or specific channels
- **Start time:** Choose start date and time for search
- **End time:** Choose end date and time for search

Press **<Search>** to start the event search. The results are listed in the table. If required, scroll to a particular page in the list of events.

To export the event file, press **<Export>**. A popup screen appears asking where to export the file, and the file format. Fill in the fields and press **<Export>** again.

The status bar shows the progress of the export.

11.3.4 Export

Here you can make a schedule for an automatic export (backup) of a recording.

- **Path:** choose where to save the backup
- **Type:** Select the type of video for back-up. Choose between: All, Regular, MD (motion detection), Alarm
- **File format:** DAV (default) or ASF
- **Bit stream type:** Main stream (default) or 2nd stream
- **Start time:** Fill in the date and start time of the backup. A backup can drain system performance. Therefore, make your backups during a quiet period when features such as local playback/export are not required
- **End time:** Fill in the end date and time of the backup
- **Cam:** Select the channel(s) to be backed up (default is All)

Press **<Add>** to add this export to the schedule list below; add more scheduled backups as required. To remove a scheduled backup, select it on the list and press **<Remove>**. Press **<Calculate>** to calculate the expected size of the export.

Press **<Start>** to start the backup.
The bottom of the screen shows the progress of the backup.

11.3.5

Setting

Click **<Setting>** to enter the Setup menu where you can configure the settings for the unit. See *Settings*, page 32 for a description of options available here.

Important: For safe HTTPS connections, you will require a trusted SSL Digital Certificate. Go to **Setting > Network > HTTPS** and follow the screen instructions to download and accept the certificate (contact your system administrator if you have any questions).

11.3.6

Info

Here you can select various sub-menus to display important system information. See *Info*, page 75 for more details.

11.3.7

Logout

Click **<Logout>** to log out of the system.

12 DIVAR Mobile Viewer

The DIVAR Mobile Viewer app gives the user remote access of the recorder with a wireless link to their mobile device. Remote live viewing, search, playback, system configuration and alarm notifications are provided. Remote control functions include pan/tilt/zoom control of cameras, and video archiving.

To access a unit, a user must log on using the same User ID and Password used for local access. The DIVAR Mobile Viewer will follow the permissions of the user account, restricting the functions available to each remote user; for example, the ability to archive video.

12.1 Getting started

Download the app

In order to use this device with the DIVAR Mobile Viewer app by Bosch, you must download the app from Google Play, or from the Apple Store.

You can access the app in several ways:

- Scan the QR code from the DIVAR local viewer in **Settings > Network > Mobile**.
- From Google Play Store (play.google.com), search for DIVAR Mobile Viewer. Select the app from the list. Click the Install button.
- From Apple Store (itunes.apple.com), search for DIVAR Mobile Viewer. Select the app from the list. Click the appropriate button to download and install the app.

Add a recorder

To add a recorder to the mobile device:

1. Open the DIVAR Mobile Viewer app.
2. In the menu select **Device Manager**.
3. Select the **+** button.
4. Give the new device a name.
5. Either:
 - Select the scan QR code button and scan the QR code in the DIVAR local viewer in **Settings > Network > Mobile**Or
 - Enter the IP address of the recorder.
6. If required change any other settings for the recorder. It is recommended to select the stream with the lowest bandwidth to reduce mobile data consumption. To do this, for **Live Preview** select **Main** instead of **Extra**.
7. Enter the password and select the disk button to save.

12.2 Live Preview

Here you can see the live streams from your cameras. Pick a favorite view or a device view from the top right menu button. Below the viewing windows the following controls can be set:

- Choose the buttons to view 1, 4, 9 or 16 cameras at once. Swipe left or right to see the next or previous view.
- Select one of the delete buttons to delete one or more selected camera streams from the view.
- Switch on or off the speaker or microphone of a camera by selecting the speaker or microphone button.
- Take a snapshot or record video of the selected stream by selecting the snapshot or record button.

On the bottom menu bar the following controls can be used:

- Pan, tilt, zoom and focus controls for cameras that support these functions.

- Select the favorites button to create new favorite views or choose already existing favorites.
- Select the home button to return to the Live Preview.
- Select the Playback button to go to the Playback page.
- Select the Alarms button to configure the alarms for the selected camera.

For more information see *Live mode*, page 66 and *Pan/Tilt/Zoom*, page 67 in the Operation chapter.

12.3 Playback

Click the Playback button to search and playback your recordings. Here you can:

- Choose up to 4 views
- press the user buttons to Play, Stop, Pause and reverse
- turn audio off or on
- jump to a specific date and time to view playback video

See *Playback*, page 69 in the Operation chapter for a detailed description.

12.4 Device Manager

In the Device Manager menu you can add a recorder or configure the settings of an existing recorder.

Add a recorder

To add a recorder to the mobile device:

1. Open the DIVAR Mobile Viewer app.
 2. In the menu select **Device Manager**.
 3. Select the **+** button.
 4. Give the new device a name.
 5. Either:
 - Select the scan QR code button and scan the QR code in the DIVAR local viewer in **Settings > Network > Mobile**
- Or
- Enter the IP address of the recorder.
6. If required change any other settings for the recorder. It is recommended to select the stream with the lowest bandwidth to reduce mobile data consumption. To do this, for **Live Preview** select **Main** instead of **Extra**.
 7. Enter the password and select the disk button to save.

Configure the recorder

When selecting a device in the device manager the following actions can be done:

- Change the name and network settings of the device
- Do a remote configuration of the device for the following settings:
 - Video detect
 - Alarm setting
 - Camera setting (only for analog cameras)
 - Storage Manager
 - Notification
- Switch the alarm outputs of the device on or off.
- View system information of the recorder such as the name, activity state, free and total capacity.
- Delete the recorder from your mobile device.

12.5 Local Files

Here you can find the snapshots and videos that were made and saved on the mobile device. They can be shared, downloaded or deleted.

12.6 Favorites

Here you can create new favorite views or choose already existing favorites.

12.7 Alarms and Push notifications

Alarms only occur if Push notifications are enabled, see **Push notifications** on how to do this. Here you can see a list of the alarms that were given per recorder with the number of unopened alarms for each recorder. Selecting an alarm opens that alarm in either **Live Preview** or **Video** (as set during configuration). They can be deleted or sorted by alarm type:

- All alarm
- Motion detect
- Input alarm
- System alarms
- Video loss
- Cam masking (only for analog cameras)

Push notifications

Push notifications allow the user to receive notifications of alarms on a mobile device. When the notifications are enabled the alarms can be found in the **Alarms** menu described earlier.

To enable push notifications on a mobile device:

1. Open the DIVAR Mobile Viewer app.
2. In the menu select **Device Manager**.
3. Select the recorder for which you want to set the notifications.
4. Go to **Remote Config > Notification > Notification config**.
5. Switch on the notifications for the device and choose the desired settings:
 - **Push type:** choose **Live Preview** to open the alarm in Live mode of the camera or **Video** to open the recorded video of the alarm.
 - **Motion detect:** choose the cameras from which you want to receive motion detect alarms.
 - **Input alarm:** in **Local alarm**, choose for which local alarms you want to receive notifications and in **Alarm ipc** choose the cameras from which you want to receive these notifications.
 - **Video loss:** choose the cameras from which you want to receive video loss alarms.
 - **System alarms:** choose the cameras from which you want to receive system alarms.
 - **Cam masking:** choose the cameras from which you want to receive cam masking alarms.

12.8 More

About

Here you can see the version of the app and other information such as:

- License
- Imprint
- Legal notice
- Privacy statement

Local Config

Here local configuration settings can be done for:

- PTZ step
- Capture Mode
- Real-time playback

13 Troubleshooting

If errors persist, a common solution is to upgrade your DVR with the latest firmware.

Cannot boot up correctly

- Input power is incorrect.
- Power connection is faulty.
- Power switch button is faulty.
- Program upgrade is incorrect.
- HDD malfunction or HDD cable connection is faulty (check HDD info screen for status).
- Front panel error.
- Main processor board is damaged.

Program upgrade is incorrect

- Check the program upgrade file is the correct version
- Try upgrading the program again
- If the upgrade still does not succeed, contact Bosch service

HDD malfunction

- Check the HDD cabling
- Format the HDD

DVR automatically shuts down or stops running

- Input voltage is not stable or is too low.
- HDD malfunction or HDD cable connection is faulty (check HDD info screen for status).
- Front video signal is not stable.
- Working environment is too harsh (e.g. too much dust) or temperature is too high or too low.
- Hardware malfunction.

System cannot detect hard disk

- HDD malfunction or HDD cable connection is faulty (check HDD info screen for status).
- Main processor board SATA port is faulty.

No video output (on one-channel, multiple-channel or all-channel output).

- Program is not compatible. Please upgrade to the latest version.
- Brightness is 0. Please restore factory default setup.
- There is no video input signal or it is too weak.
- Check privacy mask setup or your screen saver.
- DVR hardware is faulty.

Error displaying Camera x, bad signal

- Check the camera connections and replace/tighten the connections if necessary.
- Check the camera video signal and replace the camera if necessary (you can exchange connections from a correctly operating camera to test if the connections or camera are faulty)

Error displaying Out of decode

- Ensure the total amount of channels have a lower combined resolution than 16 x 1080p / 4 x 4K (for 3000/5000 models) or 8 x 1080p / 2 x 4K (for 3000/5000 models).

Real-time video color is distorted

- When using BNC output, NTSC and PAL setup is not correct (the real-time video becomes black and white).
- DVR and monitor resistance is not compatible.
- Video transmission is too long or degrading is too large.
- DVR color or brightness setup is incorrect.

Cannot search local records

- HDD malfunction or HDD cable connection is faulty (check HDD info screen for status).
- Upgraded program is not compatible.
- The recorded file has been overwritten.
- Record function has been disabled.

Video is distorted when searching local records

- Video quality setup is too low.
- Program read error, bit data is too small. There is mosaic in the full screen. Please restart the DVR to solve this problem.
- HDD malfunction or HDD cable connection is faulty (check HDD info screen for status).
- DVR hardware is faulty.

There is no audio when monitoring

- No power to pickup.
- No power to acoustics.
- Audio cable is damaged.
- DVR hardware is faulty.

There is audio when monitoring but there is no audio during playback

- Setup is incorrect. Please enable the audio function
- Corresponding channel has no video input. Playback is not continuous when the screen is blue.

Time display is incorrect

- Setup is incorrect
- Battery contact is incorrect or voltage is too low.
- LED display is faulty.

DVR cannot control PTZ

- Front panel PTZ error
- PTZ decoder setup, connection or installation is incorrect.
- Cable connection is faulty.
- PTZ setup is incorrect.
- PTZ decoder and DVR protocol is not compatible.
- PTZ decoder and DVR address is not compatible.

- When there are several decoders, please add 120 Ohm between the PTZ decoder A/B cables furthest end to delete the reverberation or impedance matching. Otherwise the PTZ control is not stable.
- The distance is too great.

Motion detection function does not work

- Ensure that the motion detection setup and sensitivity is correct for analog cameras
- Ensure that motion detection is correctly enabled and configured for IP cameras through the IP cameras web interface
- If a motion event is detected (Yellow man icon), but is not recorded, please ensure that motion recording is enabled in the schedule

Cannot log in client-end or web

- Supported OS: Windows 7 or later, please update your system.
- Ensure ActiveX control is enabled.
- No dx8.1 or higher. Please upgrade display card driver.

No video (only mosaic) during remote preview or playback of video file

- Network fluency is poor.
- Client-end resources are limited.
- Multiple-cast group setup in DVR is causing mosaic (this mode is not recommended).
- There is privacy mask or channel protection setup.
- Current user has no rights to monitor.
- DVR local video output quality is poor.
- The resolution is set too high for playback.

Network connection is instable

- Network is instable.
- IP address conflict.
- MAC address conflict.
- PC or DVR network card is faulty.

Burn error / USB backup error

- System uses too much CPU resource. Please stop recording first and then begin backup.
- Data amount exceeds backup device capacity (causing burner error).
- Backup device is not compatible.
- Backup device is damaged.

Keyboard cannot control DVR

- DVR serial port setup is incorrect.
- Address is incorrect.
- Several switchers are draining power supply.
- Transmission distance is too great.

Alarm signal cannot be disarmed

- Alarm setup is incorrect.
- Alarm output has been opened manually.
- Input device error or connection is faulty.

- Program version may be incorrect - please upgrade your system.

Alarm function is null

- Alarm setup is incorrect.
- Alarm cable connection is faulty.
- Alarm input signal is incorrect.
- Two loops connect to one alarm device.

Remote control does not work

- Remote control address is incorrect.
- Distance is too great or control angle is too small.
- Remote control battery power is low.
- Remote control or DVR front panel is damaged.

Record storage period is too short

- Camera quality is too low.
 - Lens is dirty
 - Camera is installed facing the light
 - Camera aperture setup is incorrect.
- HDD capacity is insufficient.
- HDD is damaged.

Cannot playback the downloaded file

- No media player.
- No DXB8.1 (or higher) graphic acceleration software.
- No DivX503Bundle.exe control when you play the file transformed to AVI via media player.
- No DivX503Bundle.exe or ffdshow-2004 1012.exe in Windows XP OS.

Forgotten local menu operation password or network password

Please contact your local service engineer or Bosch sales group for help.

14 Maintenance

14.1 Insert DIVAR 5000 in rack

1. Remove the four cross head screws (two on each side) located near the front panel on the right and left side of the unit.
2. Secure the supplied brackets to each side using the same four cross head screws (two on each side) that were just removed.
3. To install several units directly on top of each other, remove the rubber feet from under the unit by prying them loose with a small screwdriver.
4. Install the unit into the rack using the hardware supplied with the rack and following the rack manufacturer's instructions.
5. Support the back of the unit and secure the connection cables to the rack to relieve excessive weight to the back of the unit.

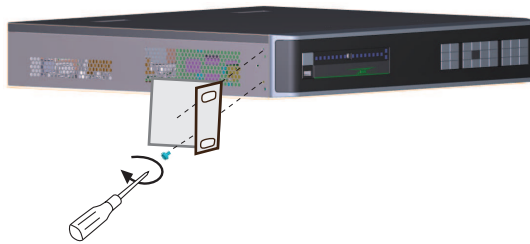

Notice!

When installing the assembly into the rack, do not restrict air flow around the vents located on the side panels or exceed the recommended operating temperature.

14.2 Replace internal battery



Warning!

Lithium battery:

Batteries that have been inserted wrongly can cause an explosion. Always replace empty batteries with batteries of the same type or a similar type recommended by the manufacturer. Handle used batteries carefully. Do not damage the battery in any way. A damaged battery may release hazardous materials into the environment.

Dispose of empty batteries according to the manufacturer's instructions, or local directives.

Replace internal battery

This product uses a 3.0 V Lithium CR2032 battery as the backup power supply for internal system status (e.g. real time clock). Under normal circumstances this battery will last a minimum of 5 years. Low battery power may mean that system time must be reset at each power up. A log message appears when the battery needs replacing (only replace when required).

Contact Bosch for replace instructions.

14.3 Install HDD

See separate Quick Install Guide.

Refer to the Appendix for recommended HDD types.

14.4 Install DVD

See separate Quick Install Guide.

Refer to the Appendix for recommended DVD types.

15 Decommissioning

15.1 Transfer

The unit should only be passed on together with this installation guide.

15.2 Disposal



Disposal - Your Bosch product was developed and manufactured with high-quality material and components that can be recycled and reused. This symbol means that electronic and electrical appliances, which have reached the end of their working life, must be collected and disposed of separately from household waste material. Separate collecting systems are usually in place for disused electronic and electrical products. Please dispose of these units at an environmentally compatible recycling facility, per *European Directive 2012/19/EU*.

16 Technical data

Environmental	
Operating temperature (incl. HDD(s) and DVD)	+0°C to +40°C (+32°F to +104°F)
Storage temperature	-40°C to +70°C (-40°F to +158°F)
Operating humidity	<93% non-condensing
Storage humidity	<95% non-condensing

DIVAR 2000/3000

Mechanical	
Dimensions (WxDxH)	375 x 323 x 53 mm (14.8 x 12.7 x 2.1 in)

Weight without PoE switch (excluding HDD(s) and DVD)	3.8 kg (8.4 lb) approx.
--	-------------------------

Weight with PoE switch (excluding HDD(s) and DVD)	4.2 kg (9.3 lb) approx.
---	-------------------------

Power	
AC input (without PoE)	100-240 VAC; 50-60 Hz; 1.9 A
AC input (with PoE)	100-240 VAC; 50-60 Hz; 5 A
RTC battery on main PCB	Lithium CR2032, 3 VDC

Power adapter DC output (without PoE)	12 VDC; 5 A
---------------------------------------	-------------

DVR Power input (without PoE)	12 VDC
-------------------------------	--------

Maximum main power consumption (no HDD)	8.7 W without PoE 15.2 W with PoE
---	--------------------------------------

Maximum power consumption of PoE+ switch	185 W
--	-------

Maximum power consumption (per PoE+ port)	25.5 W
---	--------

DIVAR 5000

Mechanical	
Dimensions (WxDxH)	440 x 408 x 76 mm (17.3 x 16.1 x 3.0 in)

Weight without PoE (excluding HDDs and DVD)	6.27 kg (13.8 lb) approx.
---	---------------------------

Weight with PoE switch (excluding HDDs and DVD)	6.37 kg (14.0 lb) approx.
---	---------------------------

Power	
AC input (without PoE)	100-240 VAC; 50-60 Hz; 1.9 A
AC input (with PoE)	100-240 VAC; 50-60 Hz; 5 A
RTC battery on main PCB	Lithium CR2032, 3 VDC
Maximum main power consumption (no HDD)	8.7 W without PoE 15.2 W with PoE
Maximum power consumption of PoE+ switch	185 W
Maximum power consumption (per PoE+ port)	25.5 W

17 Appendices

17.1 Software licenses

This product contains both software that is proprietary Bosch software licensed under the Bosch standard license terms, and software licensed on the basis of other licenses.

17.1.1 Bosch software

All Bosch software is licensed under the terms of the End User License Agreement (EULA) of Bosch Security Systems B.V. or Bosch Security Systems Inc, as available together with the physical carrier (CD or DVD). Any use is subject to agreement and compliance with such EULA, as applicable.

17.1.2 Other licenses – copyright notices

- GPL v2 copyright notice: This product includes software licensed under the GNU GPLv2 Copyright © 1989, 1991 Free Software Foundation, Inc. 51 Franklin Street, Fifth Floor, Boston, MA 02110-1301, USA.
- GPL v3 copyright notice: This product includes software licensed under the GNU GPL v3 Copyright © 2007 Free Software Foundation, Inc. (<http://fsf.org/>)
- LGPL v2.1 copyright notice: This product includes software licensed under the GNU LGPL v2.1 Copyright © 1991, 1999 Free Software Foundation, Inc. 51 Franklin Street, Fifth Floor, Boston, MA 02110-1301 USA
- SSL Copyright notice: This product includes software developed by the OpenSSL Project for use in the OpenSSL Toolkit (<http://www.openssl.org/>) Copyright © 1998-2008 The OpenSSL Project. All rights reserved.

At the time of printing this manual, the following extra licenses apply to the applicable software components included in the DIVAR:

Name software component	License (*)
GPL: busybox kernel u-boot	busybox-1.18.4.bz2 linux-4.2.tar,linux-3.10.y.tar.bz2 u-boot-2010.06.tar.bz2
Open SSL	openssl-0.9.8j.tar
LGPL: ffmpeg	ffmpeg-2.6.9.tar
Public domain: Json Sqlite	Json0.5.0.tar.bz2 sqlite-3.7.5.tar.bz2
MIT license: Lua Libpthread libva	lua.tar.bz2 libpthread-stubs-0.3.tar.gz libva-1.6.1.tar.bz2

(*) Full texts of the appropriate licenses are available at the URL links and are also delivered together with the software on the physical carrier.

Bosch is committed to comply with the relevant terms of any open source license included in its products. To this effect, Bosch has created a web site (www.boschsecurity.com/oss) to enable any licensee of open source software to have access to the relevant source code or other information that such licensee may be entitled to under the terms of a relevant license.

Any software that is licensed under an open source license, under the terms of which the licensee is entitled to obtain the program or its source code, can be obtained through the OSS web site, indicated below, for the relevant period as mentioned in the relevant open source license.

The relevant open source software can be found at:
www.boschsecurity.com/oss

To obtain the complete Corresponding Source Code in the physical medium such as CD-ROM by airmail, Bosch may charge for reasonable costs related to producing a physical carrier of open source software or source code. This offer is valid to anyone in receipt of this information.

17.1.3 Warranties and disclaimer of warranties

Software provided under other licenses has specific disclaimers of warranties. These are repeated in the full license texts, and apply in full to the relevant software components. All software components provided under the other licenses are provided "as is" without any warranty of any kind, including but not limited to any implied warranty of merchantability or fitness for a particular purpose, unless stated otherwise in writing. Please see the full text of the relevant software licenses for further details. The Bosch standard product warranty only applies to the combination of hardware and software as delivered by Bosch. Without prejudice to any licensee's right to apply the provisions of a relevant software license, any modification of any software delivered with or as part of the product may render any warranty on the whole product or any parts thereof null and void, and Bosch is entitled to charge fees for any services in relation thereto.

17.2 DVD Compatibility

DVD media compatibility list

Manufacturer	Type	Speed	Size
HP	+RW	4X	4.7 GB
Memorex	+RW	4X	4.7 GB
Sony	+RW	4X	4.7 GB
TDK	+RW	4X	4.7 GB
Verbatim	+RW	4X	4.7 GB
Maxell	+R	16X	4.7 GB
Sony	+R	16X	4.7 GB
TDK	+R	16X	4.7 GB
Verbatim	+R	16X	4.7 GB

The following DVD media have been tested on the DIVAR family for video export. Other brands/types might also work but could give problems.

Note:

DVD -R and -RW are not supported.

17.3 HDD Compatibility

The following HDDs have been tested on the DIVAR when connected to the SATA port and to the e-SATA port (only on DIVAR 5000 family).

Manufacturer	Series	Model (Bosch order no.)	Capacity
Western Digital X*	AV series	WD10PURX-xxE5EY0 (DVR-XS100-A)	1 TB
Western Digital X*	AV series	WD20PURX-xxP6ZY0 (DVR-XS200-A)	2 TB
Western Digital X*	AV series	WD30PURX-xxP6ZY0 (DVR-XS300-A)	3 TB
Western Digital X*	AV series	WD40PURX-xxGVNY0 or WD40PURX-xxNZ6Y0 (DVR-XS400-A)	4 TB
Western Digital X*	AV series	WD60PURX-xxTOZY0 (DVR-XS600-A)	6 TB

* The Western Digital PUR models are available from Bosch Security Systems as DVR-XSxx0-A Storage Expansion Kits.

Warranty and support issues:

Bosch can not be held liable for any loss or damages or system malfunction resulting from the use of non-Bosch HDDs in the DIVAR.

Bosch provides advance exchange and carry-in service on Bosch products only. Non-Bosch hard drives should be removed from DIVAR recorders when returning these units for repair. Should non-Bosch HDDs be returned, then Bosch will not be held responsible for loss of these drives or any information recorded on these drives or for any consequential damages. Bosch will not be held liable for loss or consequential damages resulting from disclosure of any information stored on non-Bosch drives.

Legal note:

Video loss is inherent to digital video recording; therefore Bosch cannot be held liable for any damage that results from missing video information. Bosch does not make any commitments or promises regarding quality, performance or other features with respect to third party HDDs. The information included here is provided "as is".

No representation or warranty, express or implied, is or will be made in relation to, and no responsibility or liability is or will be accepted by Bosch or its subsidiaries as to the accuracy or completeness of the given Information included here or any other written or oral information made available to any.



Bosch Security Systems B.V.

Torenallee 49
5617 BA Eindhoven
Netherlands

www.boschsecurity.com

© Bosch Security Systems B.V., 2018